

DAIKIN

OPERATION MANUAL MANUAL DE OPERACIÓN MANUAL DE OPERAÇÃO

使用説明書

使用说明书

English

Español

Portugues

中文
(繁體)

中文
(简体)

VRV SYSTEM

Air Conditioners

MODELS

Ceiling mounted cassette type (Round flow model)

MODELOS

Tipo cassette instalado en cielo raso (Modelo de flujo redondo)

MODELOS

Tipo casset para instalação no teto (Modelo fluxo redondo)

型號

天花板卡式嵌入型（圓形流動型）

型号

天花板卡式嵌入型（圓形流动型）

**FXFQ25PVE
FXFQ32PVE
FXFQ40PVE
FXFQ50PVE
FXFQ63PVE
FXFQ80PVE
FXFQ100PVE
FXFQ125PVE**

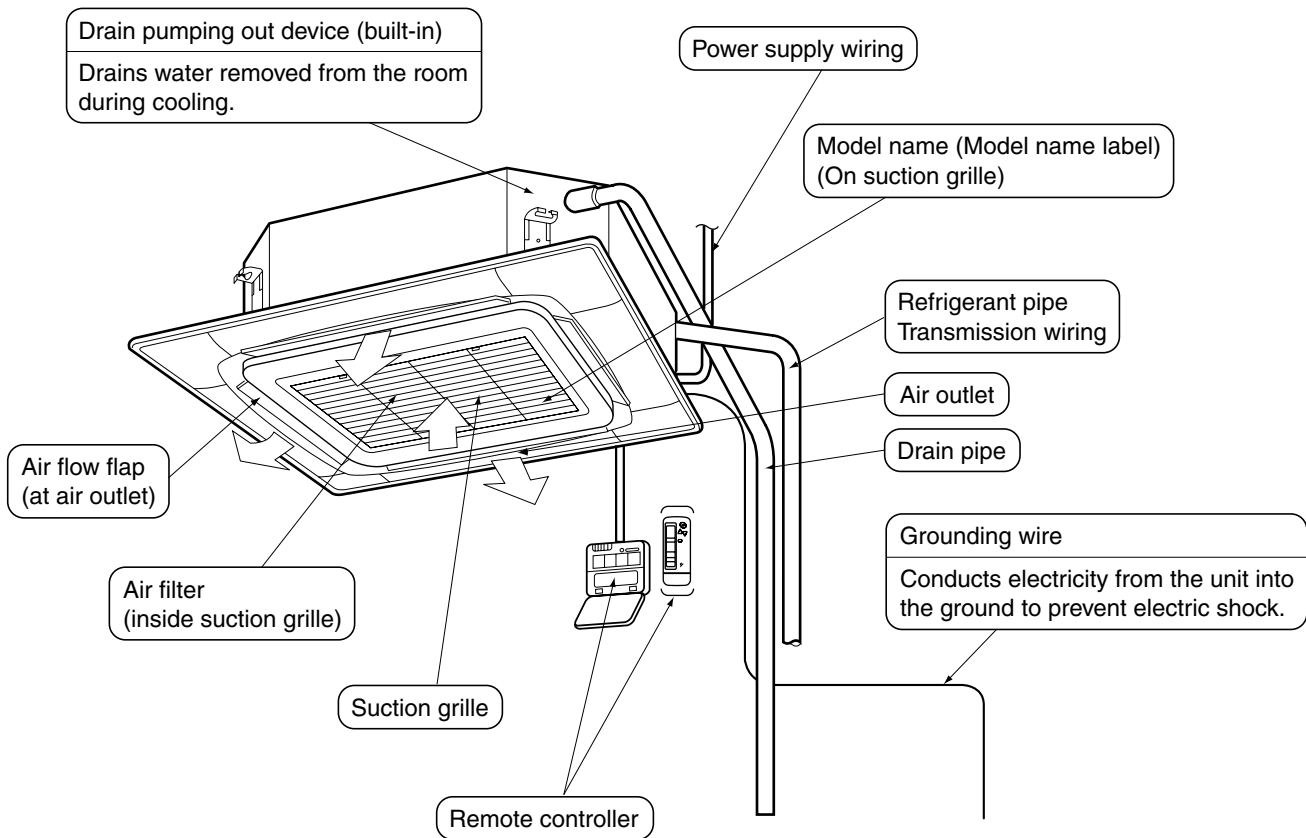

Fan speed can be selected. (HH, H, L)

Thank you for purchasing this Daikin air conditioner. Carefully read this operation manual before using the air conditioner. It will tell you how to use the unit properly and help you if any trouble occurs. This manual explains about the indoor unit only. Use it along with the operation manual for the outdoor unit. After reading the manual, file it away for future reference.

Important information regarding the refrigerant used

This product contains fluorinated greenhouse gases covered by the Kyoto Protocol.

Refrigerant type	R410A	R407C
GWP ⁽¹⁾ value	1975	1652.5

⁽¹⁾ GWP = global warming potential

Periodical inspections for refrigerant leaks may be required depending on European or local legislation. Please contact your local dealer for more information.

SAFETY PRECAUTIONS

To gain full advantage of the air conditioner's functions and to avoid malfunction due to mishandling, we recommend that you read this instruction manual carefully before use.

- This air conditioner is classified under "appliances not accessible to the general public".
- **The precautions described herein are classified as WARNING and CAUTION. They both contain important information regarding safety. Be sure to observe all precautions without fail.**

WARNING Failure to follow these instructions properly may result in personal injury or loss of life.

CAUTION Failure to observe these instructions properly may result in property damage or personal injury, which may be serious depending on the circumstances.

After reading, keep this manual in a convenient place so that you can refer to it whenever necessary. If the equipment is transferred to a new user, be sure also to hand over the manual.

WARNING

- **Consult your local dealer about installation work.** Doing the work yourself may result in water leakage, electric shocks or fire hazards.
- **Consult your local dealer regarding modification, repair and maintenance of the air conditioner.** Improper workmanship may result in water leakage, electric shocks or fire hazards.
- **Beware of fire in case of refrigerant leakage.** If the air conditioner is not operating correctly, i.e. not generating cool or warm air, refrigerant leakage could be the cause. Consult your dealer for assistance. The refrigerant within the air conditioner is safe and normally does not leak. However, in the event of a leakage, contact with a naked burner, heater or cooker may result in generation of noxious gas. Do not longer use the air conditioner until a qualified service person confirms that the leakage has been repaired.

- **Consult your local dealer regarding relocation and reinstallation of the air conditioner.**
Improper installation work may result in leakage, electric shocks or fire hazards.

CAUTION

- **Do not place objects in direct proximity of the outdoor unit and do not let leaves and other debris accumulate around the unit.**
Leaves are a hotbed for small animals which can enter the unit. Once in the unit, such animals can cause malfunctions, smoke or fire when making contact with electrical parts.
- **Do not allow a child to mount on the outdoor unit or avoid placing any object on it.**
Falling or tumbling may result in injury.
- **The appliance is not intended for use by unattended young children or infirm persons.**
Impairment of bodily functions and harm to health may result.
- **Children should be supervised to ensure that they do not play with the unit or its remote controller.**
Accidental operation by a child may result in impairment of bodily functions and harm health.
- **Do not let children play on or around the outdoor unit.**
If they touch the unit carelessly, injury may be caused.

**MAINTENANCE
(FOR SERVICE PERSONNEL)**

WARNING

- **Only a qualified person is allowed to perform maintenance without daily maintenance.**
- **Before touching any of connection wirings, be sure to turn off all power supply switches.**
- **Do not use flammable materials (e.g., hairspray or insecticide) near the product.**
Do not clean the product with organic solvents such as paint thinner.
The use of organic solvents may cause crack damage to the product, electric shocks, or fire.
- **Contact professional personnel about attachment of accessories and be sure to use only accessories specified by the manufacturer.**
If a defect results from your own workmanship, it may result in water leaks, electric shock or fire.
- **Consult your dealer regarding cleaning the inside of the air conditioner.**
Improper cleaning may cause breakage of plastic parts, water leakage and other damage as well as electric shocks.

CAUTION

- **Before cleaning, be sure to stop unit operation, turn the breaker off or remove the power cord.**
Otherwise, an electric shock and injury may result.
- **Do not wash the air conditioner with water, as this may result in electric shocks or fire.**
- **Watch your steps at the time of air filter cleaning or inspection.**
High-place work is required, to which utmost attention must be paid.
If the scaffold is unstable, you may fall or topple down, thus causing injury.

HOW TO CLEAN THE AIR FILTER

Clean the air filter when the display shows “” (TIME TO CLEAN AIR FILTER).

It will display that it will operate for a set amount of time. Increase the frequency of cleaning if the unit is installed in a room where the air is extremely contaminated. If the dirt becomes impossible to clean, change the air filter. (Air filter for exchange is optional.)

1. **Open the suction grille.**
Pull it downward slowly while pressing the buttons provided on two spots.
(Do the same procedure for closing.)

Fig. 1

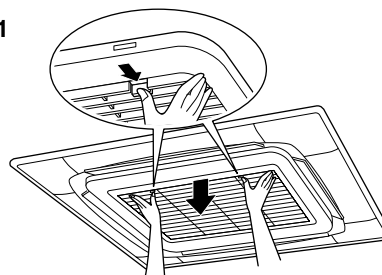

2. **Remove the air filter.**
Perform the operation in the order (1) and (2).

Fig. 2

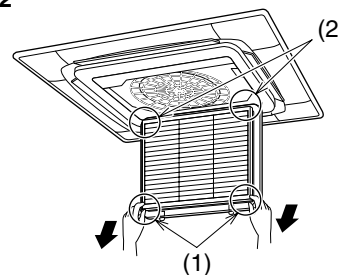

- (1) Pull the ends of the air filter down and remove the holes of the air filter from the grille protrusions. (Both left and right sides.)

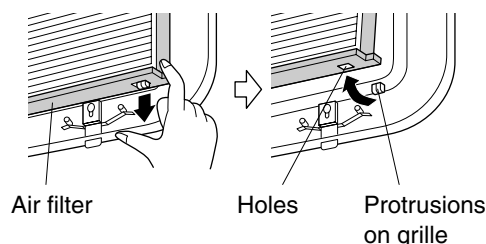

- (2) Lift the air filter and remove the holes of the air filter from the protrusions on the upper side of the grille. (Both left and right sides.)

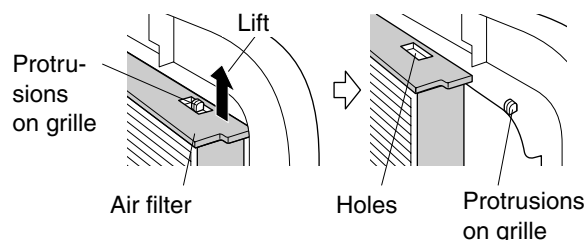

3. Clean the air filter.

Use vacuum cleaner **A)** or wash the air filter with water **B)**.

A) Using a vacuum cleaner



B) Washing with water

When the air filter is very dirty, use soft brush and neutral detergent



Remove water and dry in the shade.

NOTES

- Do not wash the air conditioner with hot water of more than 50°C. Doing so may result in discoloration or deformation.
- Never dry the filter by direct firing. Doing so may result in burning.

4. Fix the air filter.

Refer to item No. 2.

5. Shut the suction grille.

Slowly push up the suction grille, and then securely hook it onto the decoration panel while pushing the two knobs.

PRECAUTION

- When closing the suction grille, the lace might be pinched. Make sure the lace has not come out of the suction grille before closing it.

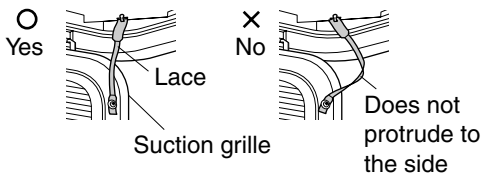

6. After turning on the power, press FILTER SIGN RESET button.

The "TIME TO CLEAN AIR FILTER" display vanishes.

HOW TO CLEAN AIR OUTLET AND OUTSIDE PANELS

- Clean with soft cloth
- When it is difficult to remove stains, use water or neutral detergent.
- When the flap is extremely contaminated, remove it as below and clean or exchange it. (Flap for exchange is optional.)

NOTES

- Do not use gasoline, benzene, thinner, polishing powder, liquid insecticide. It may cause discoloring or warping.
- Do not let the indoor unit get wet. It may cause an electric shock or a fire.
- Do not scrub firmly when washing the blade with water. The surface sealing may peel off.
- Do not use water or air of 50°C or higher for cleaning air filters and outside panels.

HOW TO CLEAN THE SUCTION GRILLE

1. Open the suction grille.

Push it downward slowly while pressing the buttons provided on two spots. (Follow the same procedure for closing.)

Fig. 3

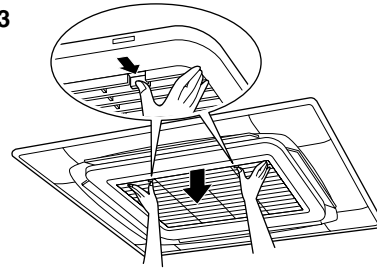

2. Remove the lace of the suction grille.

Remove the laces hooked on the two metal fittings of the panel body.

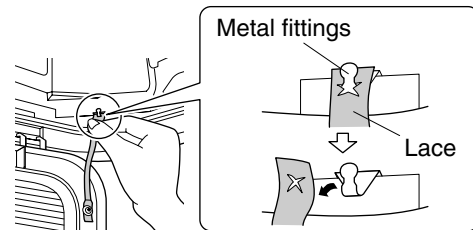

3. Detach the suction grille.

Open the suction grille 45 degrees and lift it upward.

Fig. 4

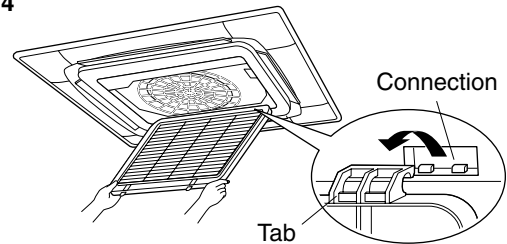

4. Detach the air filter.

Refer to "HOW TO CLEAN THE AIR FILTER". (Refer to Fig. 2)

5. Clean the suction grille.

Wash with a soft bristle brush and neutral detergent or water, and dry thoroughly.

• When very grimy

Directly apply the type of detergent used for cleaning ventilation fans or ovens, wait 10 minutes, and then rinse with water.



NOTE

- Do not wash the air conditioner with hot water of more than 50°C. Doing so may result in discoloration or deformation.

6. Reattach the air filter.

Refer to "HOW TO CLEAN THE AIR FILTER". (Refer to Fig. 2)

7. Reattach the suction grille.

Refer to item No. 2.

8. Fit the lace of the suction grille.

Fit in the reverse order of the procedure 2.

9. Close the suction grille.

Refer to item No. 1.

DAIKIN INDUSTRIES, LTD.

Head office:

Umeda Center Bldg., 2-4-12, Nakazaki-Nishi,
Kita-ku, Osaka, 530-8323 Japan

Tokyo office:

JR Shinagawa East Bldg., 2-18-1, Konan,
Minato-ku, Tokyo, 108-0075 Japan

大金工业株式会社

总公司

日本大阪府大阪市北区中崎西二丁目4番12号
梅田中心大厦 邮政编码 530-8323

东京分公司

日本東京都港区港南二丁目18番1号
JR品川东大厦 邮政编码108-0075

大金工業株式会社

總公司

日本大阪府大阪市北區中崎西二丁目4番12號
梅田中心大廈 郵政編號 530-8323

東京分公司

日本東京都港區港南二丁目18番1號
JR品川東大廈 郵政編碼108-0075