

**DAIKIN**



# OPERATION MANUAL

**Split system air conditioners**

FFQ25C2VEB  
FFQ35C2VEB  
FFQ50C2VEB  
FFQ60C2VEB

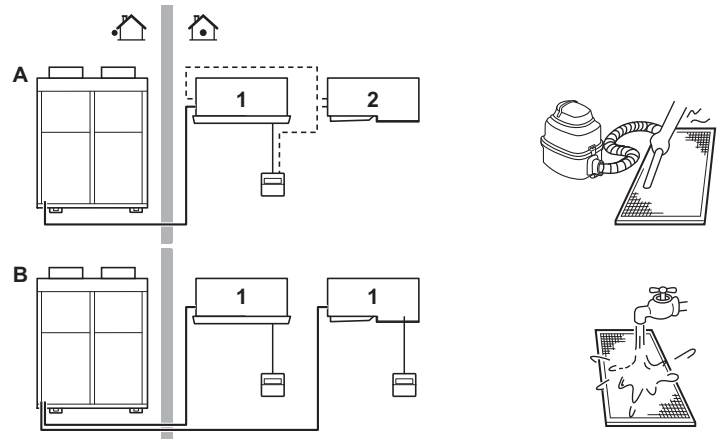
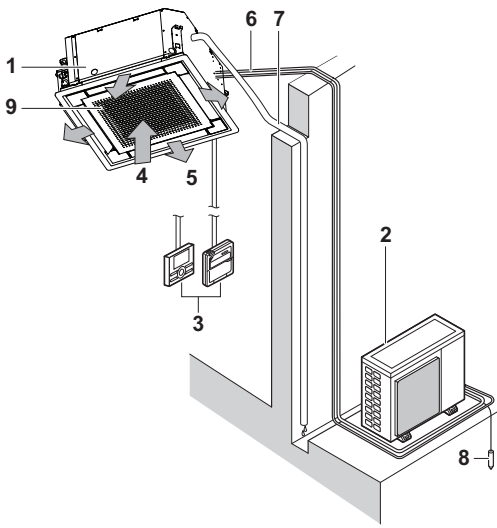

1

2

3

❄️	🏠		🔥	🏠R410A
	°C DB	°C WB		
RR71-100-125	18-35	12-28	≤80%	-15~46
RQ71-100-125	18-35	12-28	≤80%	-5~46
RXS25-35-50-60	21-32	14-23	≤80%	-10~46
2MXS40-50	21-32	14-23	≤80%	10~46
3MXS40-52-68	18-35	12-28	≤80%	-10~46
4MXS68-80	18-35	12-28	≤80%	-10~46
5MXS90	18-35	12-28	≤80%	-10~46
RZQG71-100-125-140	18-35	12-28	≤80%	-15~50
RZQSG71-100-125-140	18-35	14-28	≤80%	-5~46
RZQ200-250	18-35	14-28	≤80%	-5~46

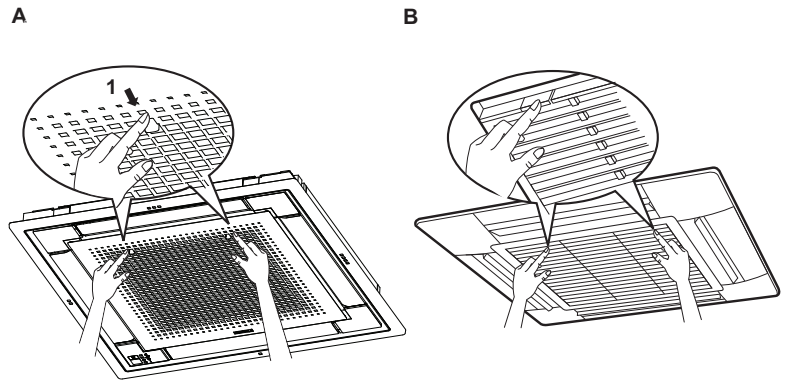

5

☀️	🏠		🏠	
	°C DB	°C WB	°C DB	°C WB
RQ71-100-125	10-27	-9~21	-10~15	
RXS25-35-50-60	10-30	-14~24	-15~18	
2MXS40-50	10-30	-14~21	-15~18	
3MXS40-52-68	10-30	-14~21	-15~18	
4MXS68-80	10-30	-14~21	-15~18	
5MXS90	10-30	-14~21	-15~18	
RZQG71-100-125-140	10-27	-19~21	-20~15.5	
RZQSG71-100-125-140	10-27	-14~21	-15~15.5	
RZQ200-250	10-27	-14~21	-15~15	

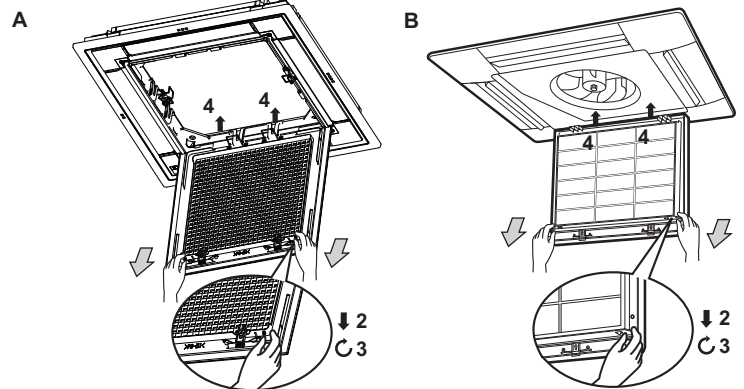

4

6

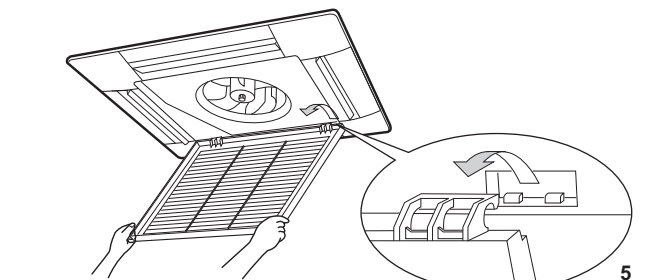
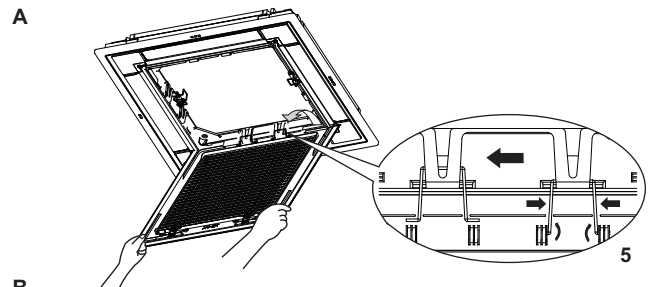
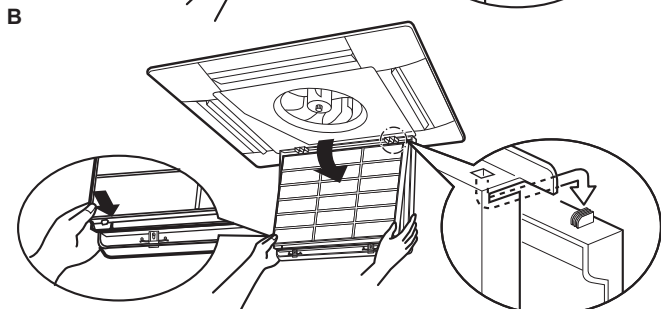
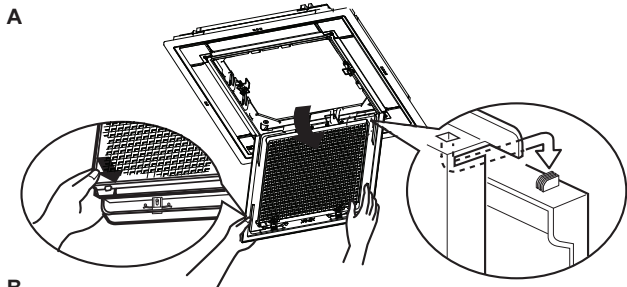

7

8

## Contents

	Page
What to do before operation .....	1
Important information regarding the refrigerant used .....	1
Safety considerations .....	1
Names and functions of parts .....	2
Operation range .....	2
Operation procedure .....	3
Optimum operation .....	3
Maintenance .....	3
Not a malfunction of the air conditioner .....	5
Troubleshooting .....	6
Disposal requirements .....	6

The English text is the original instruction. Other languages are translations of the original instructions.



THANK YOU FOR PURCHASING THIS DAIKIN AIR CONDITIONER. CAREFULLY READ THIS OPERATION MANUAL BEFORE USING THE AIR CONDITIONER. IT WILL TELL YOU HOW TO USE THE UNIT PROPERLY AND HELP YOU IF ANY TROUBLE OCCURS. AFTER READING THE MANUAL, FILE IT AWAY FOR FUTURE REFERENCE.

## What to do before operation (See figure 2)

Ask your dealer for installation and re-installation of the air conditioner.

Incomplete installation performed by yourself may result in water leakage, electric shock and fire.

Be sure only to use accessories made by Daikin which are specifically designed for use with the equipment and have them installed by a professional.

This operation manual is for the following systems with standard control. Before initiating operation, contact your dealer for the operation manual that corresponds to your system.

If your installation has a customised control system, ask your dealer for the operation that corresponds to your system.

- A Pair system or simultaneous operation system
- B Multi system
- 1 Unit with remote controller
- 2 Unit without remote controller (When used as simultaneous operation)

- Heat pump type  
This system provides cooling, heating, automatic, and fan operation modes.
- Straight cooling type  
This system provides cooling, and fan operation modes.

## Important information regarding the refrigerant used

This product contains fluorinated greenhouse gases covered by the Kyoto Protocol.

Refrigerant type: R410A

GWP<sup>(1)</sup> value: 1975

<sup>(1)</sup> GWP = global warming potential

Periodical inspections for refrigerant leaks may be required depending on European or local legislation. Please contact your local dealer for more information.

## Safety considerations

To gain full advantage of the air conditioner's functions and to avoid malfunction due to mishandling, we recommend that you read this instruction manual carefully before use.

The precautions described herein are classified as WARNING and CAUTION. They both contain important information regarding safety. Be sure to observe all precautions without fail.



### WARNING

If the warning is not observed, it may cause serious casualties.

### CAUTION

If the caution is not observed, it may cause injury or damage to the equipment.

After reading, keep this manual in a convenient place so that you can refer to it whenever necessary. If the equipment is transferred to a new user, be sure also to hand over the manual.

## Warning

- Be aware that prolonged, direct exposure to cool or warm air from the air conditioner, or to air that is too cool or too warm can be harmful to your physical condition and health.
- When the air conditioner is malfunctioning (giving off a burning odour, etc.) turn off power to the unit and contact your local dealer. Continued operation under such circumstances may result in a failure, electric shocks or fire hazards.
- Do not attempt to install or repair the air conditioner yourself. Improper workmanship may result in water leakage, electric shocks or fire hazards. Please contact your local dealer or qualified personnel for installation and maintenance work.
- Do not place objects, including rods, your fingers, etc., in the air inlet or outlet. Injury may result due to contact with the air conditioner's highspeed fan blades.
- Consult your local dealer regarding what to do in case of refrigerant leakage. When the air conditioner is to be installed in a small room, it is necessary to take proper measures so that the amount of any leaked refrigerant does not exceed the concentration limit in the event of a leakage. Otherwise, this may lead to an accident due to oxygen depletion.
- Contact professional personnel about attachment of accessories and be sure to use only accessories specified by the manufacturer. If a defect results from your own workmanship, it may result in water leaks, electric shock or fire.
- Consult your local dealer regarding relocation and reinstallation of the air conditioner. Improper installation work may result in leakage, electric shocks or fire hazards.

- Beware of fire in case of refrigerant leakage. If the air conditioner is not operating correctly, i.e. not generating cool or warm air, refrigerant leakage could be the cause. Consult your dealer for assistance. The refrigerant within the air conditioner is safe and normally does not leak. However, in the event of a leakage, contact with a naked burner, heater or cooker may result in generation of noxious gas. Do not longer use the air conditioner until a qualified service person confirms that the leakage has been repaired.
- Be sure to use fuses with the correct ampere reading. Do not use improper fuses, copper or other wires as a substitute, as this may result in electric shock, fire, injury or damage to the unit.

### Caution

- Do not use the air conditioner for purposes other than those for which it is intended. Do not use the air conditioner for cooling precision instruments, food, plants, animals or works of art as this may adversely affect the performance, quality and/or longevity of the object concerned.
- Do not remove the outdoor unit's fan guard. The guard protects against the unit's highspeed fan, which may cause injury.
- To avoid oxygen depletion, ensure that the room is adequately ventilated if equipment such as a burner is used together with the air conditioner.
- After prolonged use, check the unit stand and its mounts for damage. If left in a damaged condition, the unit may fall and cause injury.
- Do not place flammable sprays or operate spray containers near the unit as this may result in fire.
- Before cleaning, be sure to stop unit operation, turn the breaker off and remove the power cord. Otherwise, an electric shock and injury may result.
- To avoid electric shocks, do not operate with wet hands.
- Do not place objects that are susceptible to moisture directly beneath the indoor or outdoor units. Under certain conditions, condensation on the main unit or refrigerant pipes, air filter dirt or drain blockage may cause dripping, resulting in fouling or failure of the object concerned.
- Do not place burners or heaters in places exposed to the air flow from the unit as this may impair combustion of the burner or heater.
- Do not allow children to climb on the outdoor unit and avoid placing objects on the unit. Injury may result if the unit becomes loose and falls.
- Do not expose plants or animals directly to air flow from the unit as this may cause adverse effects.
- Do not wash the air conditioner with water, as this may result in electric shocks or fire.
- This appliance is not intended for use by persons, including children, with reduced physical, sensory or mental capabilities, or lack of experience and knowledge, unless they have been given supervision or instruction concerning use of the appliance by a person responsible for their safety. Children should be supervised to ensure that they do not play with the appliance.
- This appliance is intended to be used by expert or trained users in shops, in light industry and on farms, or for commercial use by lay persons.
- Children should be supervised to ensure that they do not play with the unit or its remote controller. Accidental operation by a child may result in impairment of bodily functions and harm health.
- Consult your dealer regarding cleaning the inside of the air conditioner. Improper cleaning may cause breakage of plastic parts, water leakage and other damage as well as electric shocks.
- To avoid injury, do not touch the air inlet or aluminium fins of the unit.

- Do not place objects in direct proximity of the outdoor unit and do not let leaves and other debris accumulate around the unit. Leaves are a hotbed for small animals which can enter the unit. Once in the unit, such animals can cause malfunctions, smoke or fire when making contact with electrical parts.
- Sound level is less than 70 dB(A).

## Names and functions of parts

(See figure 1)

- 1 Indoor unit
- 2 Outdoor unit
- 3 Remote controller
- 4 Inlet air
- 5 Discharged air
- 6 Refrigerant piping, connection electric wire
- 7 Drain pipe
- 8 Ground wire  
Wire to ground outdoor unit to prevent electric shocks.
- 9 Suction grille and air filter

### NOTE



These units can be controlled by a remote controller. Refer to the manual of the remote controller for more information.

Never press the button of the remote controller with a hard pointed object. The remote controller may get damaged.

Never pull or twist the electric wire of a remote controller. It may cause the unit to malfunction.

Never touch the internal parts of the controller. Do not remove the front panel. Some parts inside are dangerous to touch and a machine trouble may happen. For checking and adjusting the internal parts, contact your dealer.

Do not wipe the controller operation panel with benzene, thinner, chemical dust cloth, etc.

The panel may get discolored or the coating may peel off. If it is very dirty, soak a cloth in water-diluted neutral detergent, squeeze it well and wipe the panel clean. Wipe it with another dry cloth.

## Operation range (See figure 4)

If operating outside the following conditions, safety devices may activate, rendering the air conditioner inoperable or may cause the indoor unit to sweat.

The setting temperature range of the remote controller is 16°C–32°C.

(DB=dry bulb, WB=wet bulb, ❄️=cooling, ☀️=heating, 🏠=indoor, 🏡=outdoor, 🌡️°C=temperature, 💧=humidity)

## Precautions for group control system or two remote controller control system

This system provides two other control systems beside individual control (one remote controller controls one indoor unit) system. Confirm the following if your unit is of the following control system type.

- Group control system  
One remote controller controls up to 16 indoor units. All indoor units are equally set.
- Two remote controller control system  
Two remote controllers control one indoor unit (In case of group control system, one group of indoor units). The unit is individually operated.

**NOTE**

Contact your dealer in case of changing the combination or setting of group control and two remote controller control systems.

## Operation procedure



- Read the operation manual supplied with the remote controller.
- If a function that is not available is selected, the message NOT AVAILABLE will appear.
- Operating procedure varies with heat pump type and straight cooling type. Contact your dealer to confirm your system type.
- To protect the unit, turn on the main power switch 6 hours before operation.
- If the main power supply is turned off during operation, operation will restart automatically after the power turns back on again.

**NOTE**

Set the temperature within the ranges mentioned under "Operation range" on page 2.

## Optimum operation

Observe the following precautions to ensure the system operates properly.

- Fully use the function of air flow direction adjustment.  
As cold air gathers on the floor and warm air gathers against the ceiling, it is recommended to set the air flow direction during cooling or dry operation parallel to the ceiling and to set it downwards during heating operation.  
Beware on the other hand, to avoid direct air flow to room inhabitants.
- Adjust the room temperature properly for a comfortable environment. Avoid excessive heating or cooling.  
Notice that it may take some time for the room temperature to reach the set temperature. Consider therefore to take advantage of the timer setting possibilities.
- Prevent direct sunlight from entering a room during cooling operation by using curtains or blinds.
- Ventilate the room regularly. Using the unit for long periods of time requires attentive ventilation of the room.
- Do not operate the air conditioner when using a room fumigation-type insecticide.  
Failure to observe this could cause the chemicals to become deposited in the unit, which could endanger the health of those who are hypersensitive to chemicals.
- Keep doors and windows closed. If the doors and windows remain open, room air will flow out and decrease the effect of cooling and heating.
- Never place objects near the air inlet and the air outlet of the unit. It may retard effectiveness or cause operation to stop.
- Turn off the main power supply switch when not using for long periods of time. Electricity is consumed as long as the switch is on. Turn off the main power supply switch in order to save energy. Turn on the main power supply switch 6 hours before restarting operation in order to ensure smooth operation. (Refer to "Maintenance" on page 3.)
- When the display shows ".." (TIME TO CLEAN AIR FILTER), have a qualified service person to clean the filters. (Refer to "Maintenance" on page 3.)



Do not use the air conditioner for other purposes.

In order to avoid any quality deterioration, do not use the unit for cooling precision instruments, food, plants, animals or works of art.

## Maintenance

**CAUTION**

- Only a qualified service person is allowed to perform maintenance.
- Before obtaining access to terminal devices, all power supply circuits must be interrupted.
- To clean the air conditioner or air filter, be sure to stop operation and turn all power supplies off. Otherwise, an electric shock and injury may result.
- Do not wash the air conditioner with water. Doing so may result in an electric shock.
- Be careful with scaffoldings. Caution must be exercised when working in high places.
- After a long use, check the unit stand and fitting for damage. If damaged, the unit may fall and cause injury.
- Do not touch the heat exchanger fins. The fins are sharp and could result in cutting injuries.
- When cleaning the heat exchanger, be sure to remove the control box, fan motor, drain pump and float switch. Water or detergent may deteriorate the insulation of electronic components and result in burn-out of these components.

### How to clean the air filter

Clean the air filter when the display shows ".." (TIME TO CLEAN AIR FILTER).

Increase the frequency of cleaning if the unit is installed in a room where the air is extremely contaminated.

(As a yardstick for yourself, consider cleaning the filter once half a year.)

If the dirt becomes impossible to clean, change the air filter. (Air filter for exchange is optional.)

**NOTE**

Do not wash the air filter with hot water of more than 50°C. Doing so may result in discoloration and/or deformation.

Do not expose the unit to fire. Doing so may result in burning.

In case of decoration panel BYFQ60C see figures marked **A**  
BYFQ60B see figures marked **B**

- 1 Open the suction grille (See figure 5) (action 1 in the illustration). Push both levers simultaneously in the direction of the arrow as indicated in the illustration and carefully lower the grille. (Identical procedure for closing.)
- 2 Remove the air filter (See figure 6) (actions 2 to 4 in the illustration).  
Pull the air filter clip on both the bottom left and the right side of the filter toward you, and detach the filter.
- 3 Clean the air filter. (See figure 3)  
Use vacuum cleaner or wash the air filter with water.  
When the air filter is very dirty, use soft brush and neutral detergent.
- 4 Remove water and dry in the shade.
- 5 Install the air filter back in place (perform actions 2 to 4 in the illustration in reverse order).  
Attach the air filter to the suction grille by hanging it over the projected portion above the suction grille.  
Press the bottom of the air filter against the projections on the bottom of the grille to snap the air filter into its place.
- 6 Close the suction grille by performing procedure step 1 in reverse order.
- 7 After turning on the power, press the FILTER SIGN RESET button. The "TIME TO CLEAN AIR FILTER" display vanishes.

## How to clean the suction grille

In case of decoration panel BYFQ60C see figures marked **A**  
BYFQ60B see figures marked **B**

- 1 Open the suction grille (See figure 5) (action 1 in the illustration). Refer to procedure step 1 in "How to clean the air filter" on page 3.
- 2 Detach the suction grille (See figure 6).  
A: Open the suction grille 90 degrees and it will hang only on the hinges.  
Press both wires hinges inward as shown in the figure 8A.  
B: Open the suction grille 45 degrees and lift it upward as shown in the figure 8B.
- 3 Remove the air filter (actions 2 to 4 in the illustration). Refer to procedure step 2 in "How to clean the air filter" on page 3.
- 4 Clean the suction grille.  
Wash with a soft bristle brush and neutral detergent or water, and dry thoroughly.

**NOTE**  When the suction grille is very dirty, use a typical kitchen cleaner and let it sit for about 10 minutes. Then, wash it with water.  
Do not wash the suction grille with hot water of more than 50°C. Doing so may result in discoloration and/or deformation.

- 5 Install the air filter back in place (perform actions 2 to 4 in the illustration in reverse order).
- 6 Reattach the suction grille by performing procedure step 2 in reverse order (perform action 5 in the illustration in reverse order).
- 7 Close the suction grille by performing procedure step 1 in reverse order.

## How to clean air outlet and outside panels

- Clean with soft cloth.
- When it is difficult to remove stains, use water or neutral detergent.

**NOTE**  Do not use gasoline, benzene, thinner, polishing powder, liquid insecticide. It may cause discoloring or warping.  
Do not let the indoor unit get wet. It may cause an electric shock or a fire.  
Do not scrub firmly when washing the blade with water. The surface sealing may peel off.  
Do not use water or air of 50°C or higher for cleaning air filters and outside panels.

## Start-up after a long stop

- Confirm the following.
  - Check that the air inlet and outlet are not blocked. Remove any obstacle.
  - Check if the earth is connected.
  - Is there a broken wire somewhere? Contact your dealer if there are any problems.
- Clean the air filter and outside panels.
  - After cleaning the air filter, make sure to attach it.
- Turn on the main power supply switch.
  - The control panel display lights when the power is turned on.
  - To protect the unit, turn on the main power switch at least 6 hours before operation.

## What to do when stopping the system for a long period



- Turn on FAN OPERATION for a half day and dry the unit.
  - Refer to the manual of the remote controller.
- Cut off the power supply.
  - When the main power switch is turned on, some wattage is being consumed even if the system is not operating.
  - The remote controller display will be switched off when the main power switch is turned off.
- Clean the air filter and the exterior. Be sure to replace the air filter to its original place after cleaning. Refer to "Maintenance" on page 3.



## Not a malfunction of the air conditioner

The following symptoms do not indicate air conditioner malfunction.

### The system does not operate

- The system does not restart immediately after the ON/OFF button is pressed.  
If the OPERATION lamp lights, the system is in its normal operating condition.  
It does not restart immediately because one of its safety devices actuates to prevent the system from being overloaded.  
The system will turn on again automatically after three minutes.
- The system does not restart immediately when the TEMPERATURE SETTING button is returned to its former position after pushing.  
It does not restart immediately because one of its safety devices actuates to prevent the system from being overloaded.  
The system will turn on again automatically after three minutes.
- The system does not start when the display shows "" (EXTERNAL CONTROL ICON) and it flashes for a few seconds after pressing an operation button.  
This is because the system is controlled or disabled by another controller with a higher priority.  
When the display flashes, it indicates that the system cannot be controlled by this indoor unit.
- The system does not start immediately after the power supply is turned on.  
Wait one minute until the micro computer is prepared for operation.
- The outdoor unit has stopped.  
This is because the room temperature has reached the set temperature. The unit switches to fan operation.  
"" (EXTERNAL CONTROL ICON) is displayed on the remote controller and the actual operation is different from the remote controller setting.  
For multi split models, the micro computer executes the following control depending on the operation mode of other indoor units.
  - Before you start to operate, the other indoor unit(s) is (are) already operating. When the operation mode of this unit is different from your choice, the indoor unit of your room may be put in waiting condition. (Fan: Stop, Horizontal flap: Horizontal position)

Your room	Operation mode			
	Cooling	Dry	Fan only	Heating
Cooling	O	O	O	W
Dry	O	O	O	W
Fan only	O	O	O	W
Heating	W	W	W	O

O: your unit can operate  
W: your unit in waiting mode

- When the total cooling capacity of all indoor units which are operating is beyond the capacity limit of the outdoor unit, your indoor unit will be put in waiting condition. (Fan and horizontal flap: Same as setting: (cooling only model))
- After cooling mode operation of the unit of your room, when other unit(s) start to operate, the unit of your room may operate as follows: Fan: L tab, Horizontal flap: Horizontal position.
- The fan speed is different from the setting. Pressing the fan speed control button does not change the fan speed.  
When the room temperature reaches the set temperature in heating mode, the capacity supply from the outdoor unit has stopped and the indoor unit operates in fan only mode (L tab). In case of multi split, the indoor unit alternately operates fan stop and fan only mode (L tab).  
This is to prevent the cool air from being blown directly onto anyone present in the room.

### Air blow direction is not as specified

- Actual air blow direction is not as shown on the remote controller.
- Automatic swing setting does not work.

Refer to the manual of the remote controller.

### White mist comes out of a unit

- When humidity is high during cooling operation (In oily or dusty places).  
If the inside of an indoor unit is extremely contaminated, the temperature distribution inside a room becomes uneven. It is necessary to clean the inside of the indoor unit. Ask your dealer for details on cleaning the unit. This operation requires a qualified service person.
- When the system is changed over to HEATING OPERATION after DEFROST OPERATION.  
Moisture generated by DEFROST becomes steam and exits.

### Noise of air conditioners

- A "ringing" sound is heard after the unit is started.  
This sound is generated by the temperature regulator working. It will quiet down after about a minute.
- A continuous low "hissing" sound is heard when the system is in COOLING or DEFROST OPERATION.  
This is the sound of refrigerant gas flowing through both indoor and outdoor units.
- A "hissing" sound which is heard at the start or immediately after the stop of operation or which is heard at the start or immediately after the stop of DEFROST OPERATION.  
This is the noise of refrigerant caused by flow stop and flow change.
- A continuous low "swishing" sound is heard when the system is in COOLING OPERATION or at a stop.  
The noise is heard when the drain pump is in operation.
- A "squeaking" sound is heard when the system is in operation or after the stop of operation.  
Expansion and contraction of plastic parts caused by temperature change makes this noise.

### Dust from the units

- Dust may blow out from the unit after starting operation from long resting time. Dust absorbed by the unit blows out.

### The units give off odours

- The unit absorbs the smell of rooms, furniture, cigarettes, etc., and then emits them.

### The liquid crystal display of the remote controller shows "88"

- Happens immediately after the main power supply switch is turned on.  
Shows that the remote controller is in normal condition. Continues temporarily.

## Troubleshooting

If one of the following malfunctions occurs, take the measures shown below and contact your dealer.

The system must be repaired by a qualified service person.



### WARNING

When the air conditioner is in abnormal conditions (burning smell, etc.) unplug the power cord from the outlet and contact your dealer.

Continued operation under such circumstances may result in a failure, electric shock and fire.

- If a safety device such as a fuse, a breaker, or an earth leakage breaker frequently actuates, or ON/OFF switch does not properly work.  
Measure: Turn off the main power switch.
- If water leaks from unit.  
Measure: Stop the operation.
- If the display "⊕" (INSPECTION), "UNIT No.", and the OPERATION lamp flashes and the "MALFUNCTION CODE" appears.  
Measure: Notify your dealer and inform him/her of the display.

If the system does not operate properly, except for the above mentioned case, and none of the above mentioned malfunctions are evident, investigate the system according to the following procedures.

#### ***If the system does not operate at all.***

- Check if there is a power failure.  
Wait until power is restored. If power failure occurs during operation, the system automatically restarts immediately after the power supply recovers.
- Check if the fuse has blown or breaker has been tripped.  
Change the fuse or set the breaker.

#### ***If the system stops operating after operation is complete.***

- Check if the air inlet or outlet of outdoor or indoor unit is blocked by obstacles.  
Remove the obstacle and make it well-ventilated.
- Check if the air filter is clogged.  
Ask a qualified service person to clean the air filter.

#### ***The system operates but it does not sufficiently cool or heat.***

- If the air inlet or outlet of the indoor or the outdoor unit is blocked with obstacles.  
Remove the obstacle and make it well-ventilated.
- If the air filter is clogged.  
Ask a qualified service person to clean the air filter.
- If the set temperature is not proper. (Refer to the manual of the remote controller)
- If the FAN SPEED CONTROL button is set to LOW SPEED. (Refer to the manual of the remote controller)
- If the air flow angle is not proper. (Refer to the manual of the remote controller)
- If the doors or the windows are open. Shut doors or windows to prevent wind from coming in.
- If direct sunlight enters the room (when cooling).  
Use curtains or blinds.
- When there are too many inhabitants in the room. Cooling effect decreases if heat gain of the room is too large.
- If the heat source of the room is excessive (when cooling).  
Cooling effect decreases if heat gain of the room is too large.

## Disposal requirements

Dismantling of the unit, treatment of the refrigerant, of oil and of other parts must be done in accordance with relevant local and national legislation.



Your air conditioning product is marked with this symbol. This means that electrical and electronic products shall not be mixed with unsorted household waste.

Do not try to dismantle the system yourself: the dismantling of the air conditioning system, treatment of the refrigerant, of oil and of other parts must be done by a qualified installer in accordance with relevant local and national legislation.

Air conditioners must be treated at a specialized treatment facility for re-use, recycling and recovery. By ensuring this product is disposed of correctly, you will help to prevent potential negative consequences for the environment and human health. Please contact the installer or local authority for more information.

Batteries must be removed from the remote controller and disposed of separately in accordance with relevant local and national legislation.



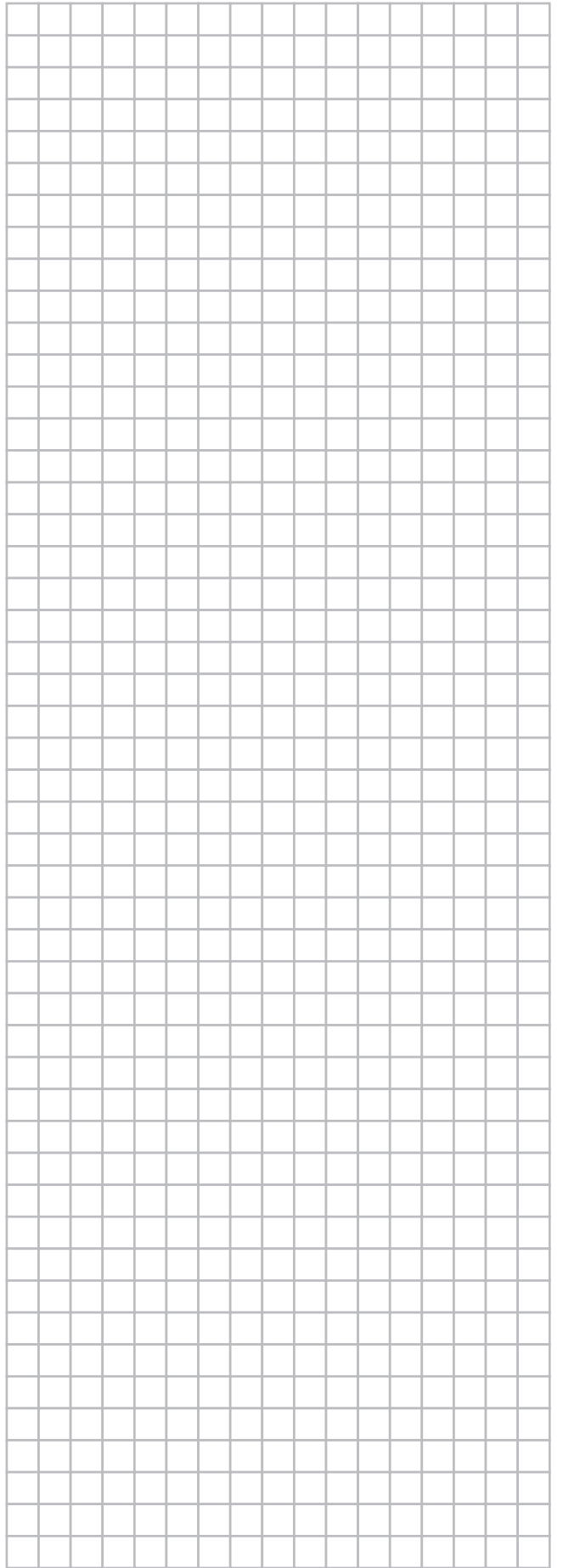
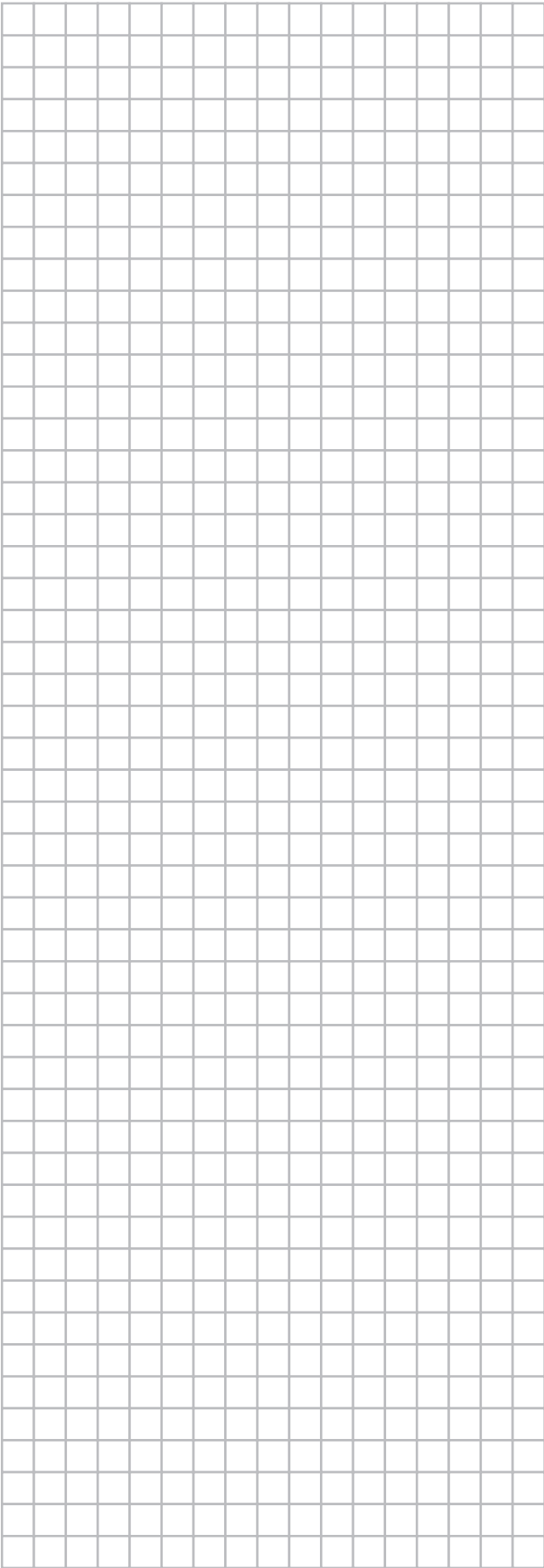

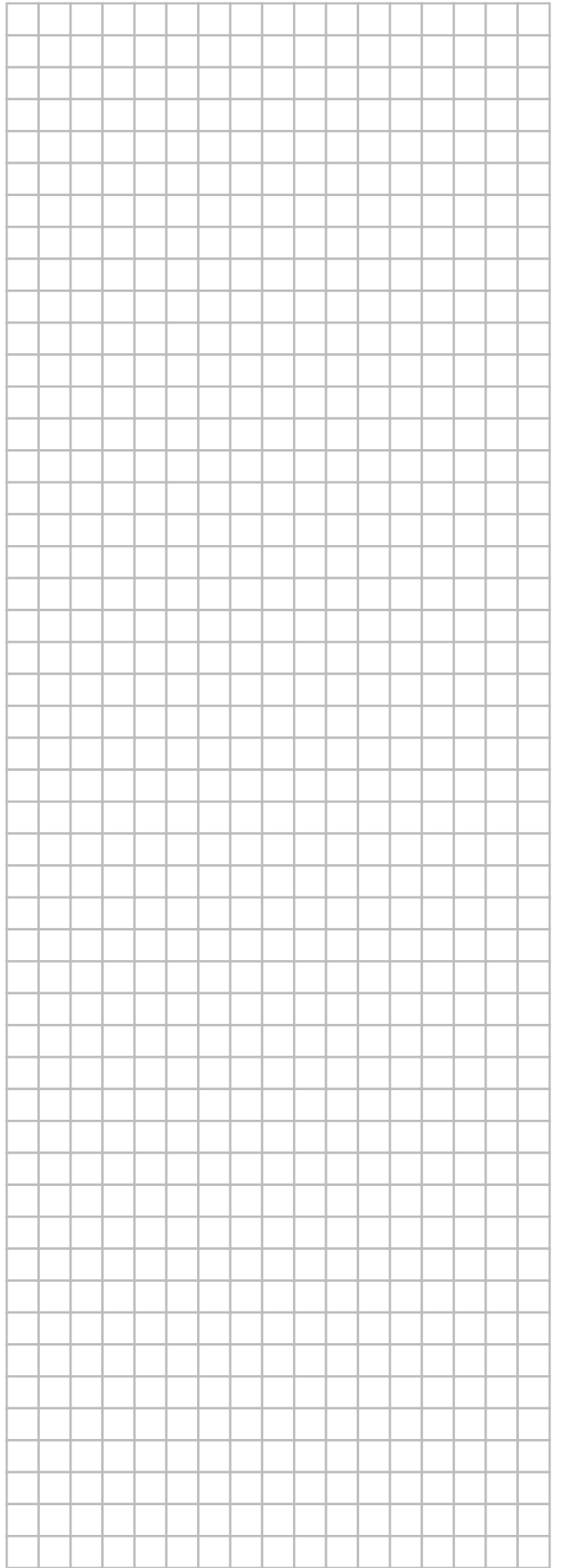
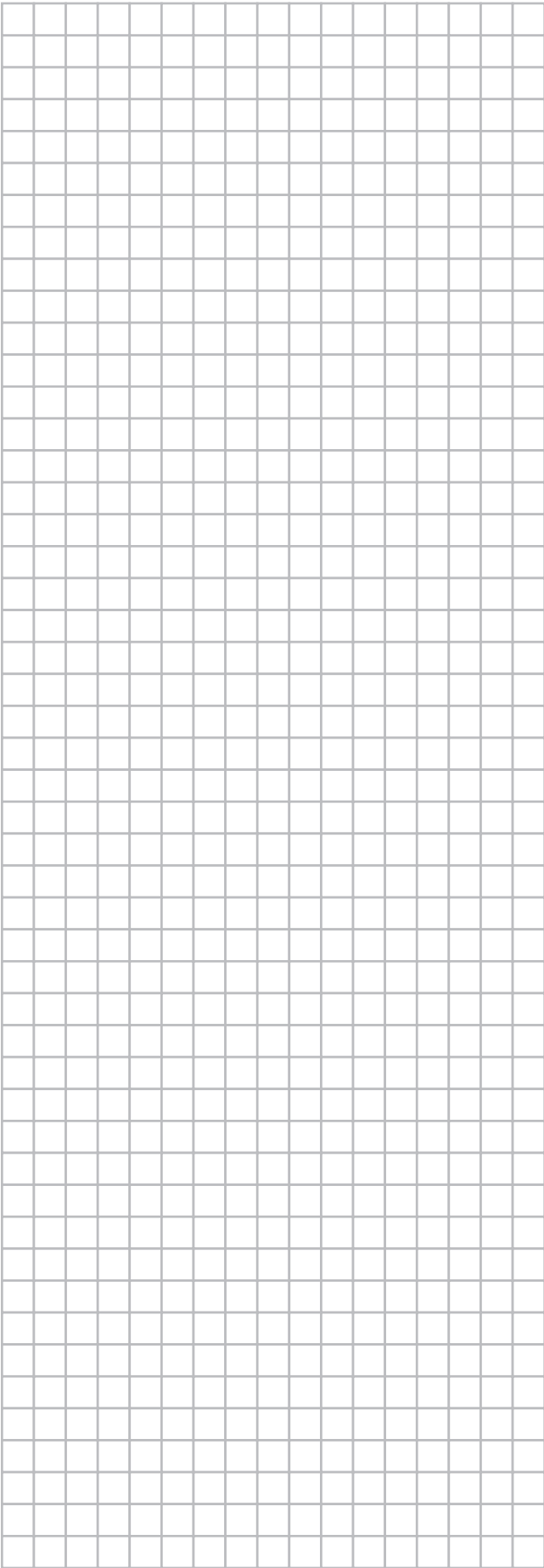

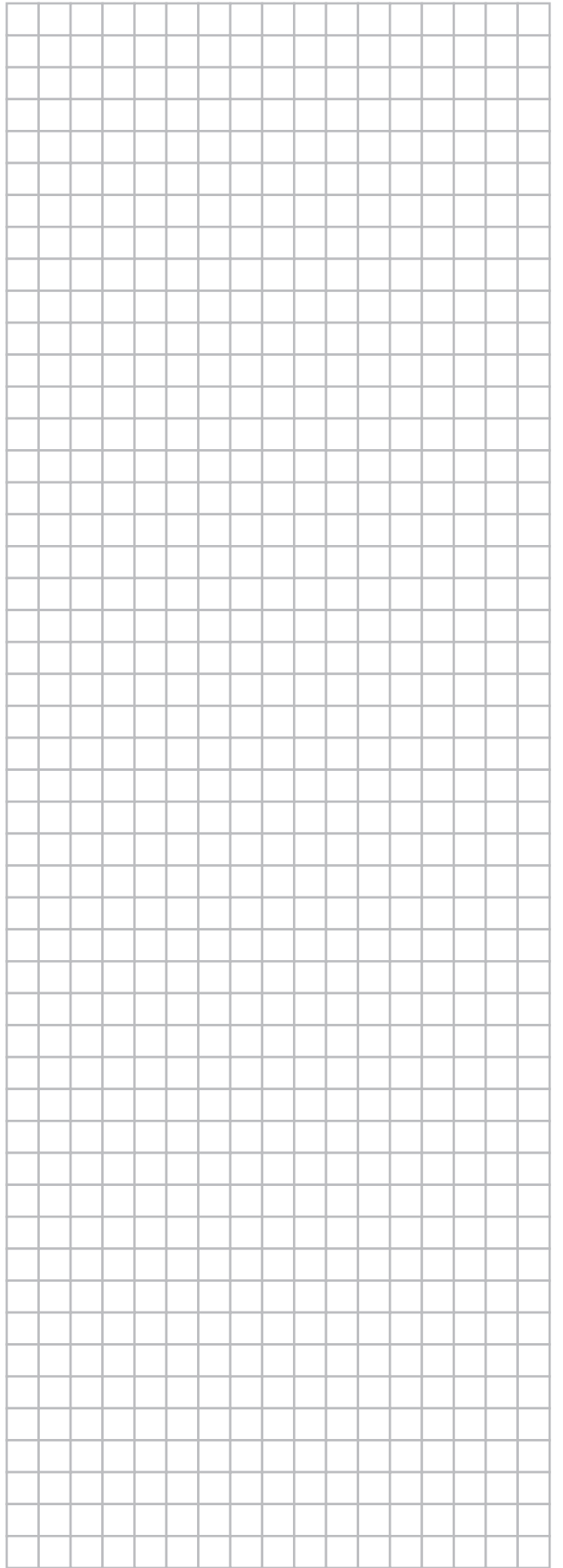
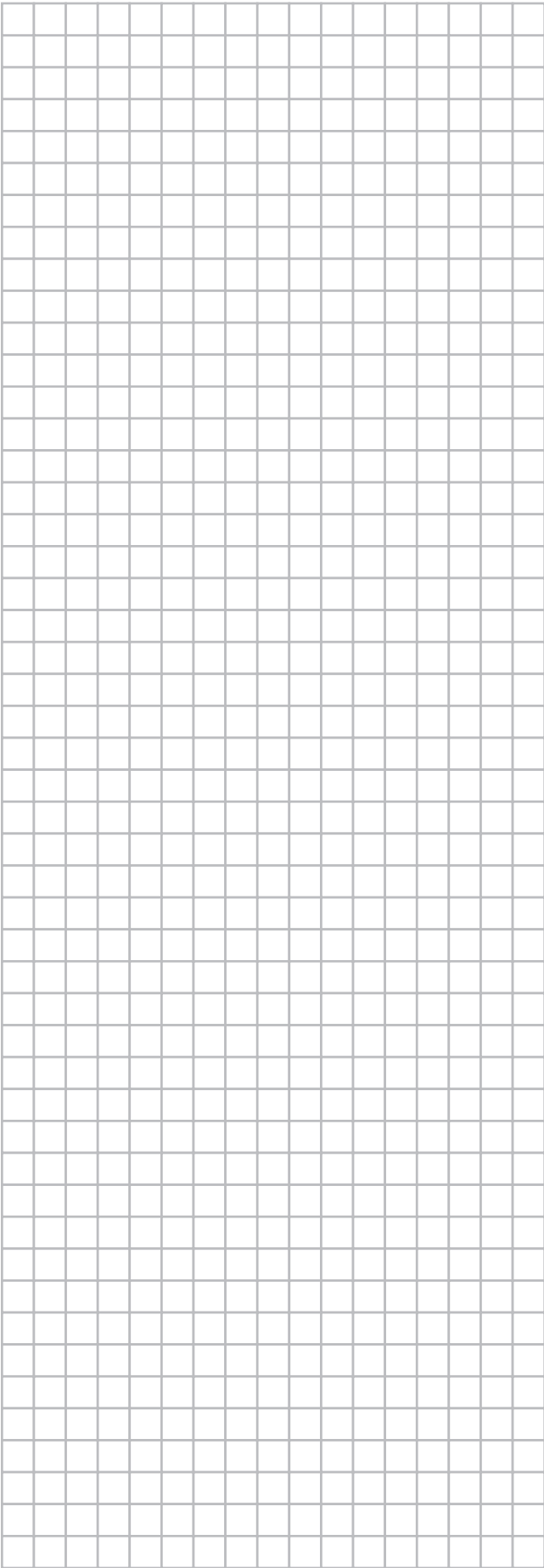

**DAIKIN INDUSTRIES CZECH REPUBLIC s.r.o.**

U Nové Hospody 1/1155, 301 00 Plzeň Skvrňany, Czech Republic

**DAIKIN EUROPE N.V.**

Zandvoordestraat 300, B-8400 Oostende, Belgium

Copyright 2013 Daikin

