

DAIKIN

INSTALLATION MANUAL

R410A Split Series

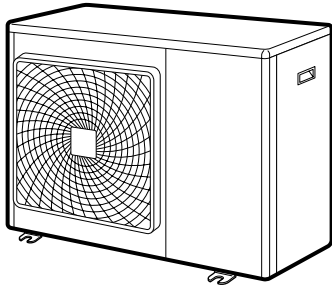

Models

RXS71FV1B

RKS71FV1B

Installation manual
R410A Split series

English

Installationsanleitung
Split-Baureihe R410A

Deutsch

Manuel d'installation
Série split R410A

Français

Montagehandleiding
R410A Split-systeem

Nederlands

Manual de instalación
Serie Split R410A

Español

Manuale d'installazione
Serie Multiambienti R410A

Italiano

Εγχειρίδιο εγκατάστασης
διαιρούμενης σειράς R410A

Ελληνικά

Manual de Instalação
Série split R410A

Portugues

Руководство по монтажу
Серия R410A с раздельной установкой

Русский

Montaj kılavuzları
R410A Split serisi

Türkçe

01	Note *	as set out in the Technical Construction File Dainin.TCF.015 and judged positively by KEIMA according to the Certificate 74736-KRQ/EMC97-4957.	10	Bemærk *	som anført i den Tekniske Konstruktionsfil Dainin.TCF.015 og positivt vurderet af KEIMA i henhold til Certifikat 74736-KRQ/EMC97-4957.	19	Opomba *	koji je določeno v tehnični mapi Dainin.TCF.015 in odobreno s strani KEIMA v skladu s certifikatom 74736-KRQ/EMC97-4957.
02	Hinweis *	wie in der Technischen Konstruktionsakte Dainin.TCF.015 aufgeführt und von KEIMA positiv ausgezeichnet gemäß Zertifikat 74736-KRQ/EMC97-4957.	11	Information *	urustingen är utförd i enlighet med den Tekniska Konstruktionsfilen Dainin.TCF.015 som positivt utlygges av KEIMA vilket också framgår av Certifikat 74736-KRQ/EMC97-4957.	20	Märkus *	nagu on mädatud tehnilises dokumentatsioonis Dainin.TCF.015 ja heaks kiitnud KEIMA järgi vastavalt sertifikaadile 74736-KRQ/EMC97-4957.
03	Remarque *	tel que stipulé dans le Fichier de Construction Technique Dainin.TCF.015 et jugé positivement par KEIMA conformément au Certificat 74736-KRQ/EMC97-4957.	12	Merk *	Som det fremkommer i den Tekniske Konstruktionsfilen Dainin.TCF.015 og gennem positiv bedømmelse av KEIMA ifølge Certifikat 74736-KRQ/EMC97-4957.	21	Zabovlečka *	както е записано в Акта за техничка конструкција Dainin.TCF.015 и оценено потковително от KEIMA съгласно Сертификат 74736-KRQ/EMC97-4957.
04	Bemerk *	zoals vermeld in het Technisch Constructie dossier Dainin.TCF.015 en in orde bevonden door KEIMA overeenkomstig het Certificaat 74736-KRQ/EMC97-4957.	13	Huom *	joska on esitetty Teknisessä Asiantuntijassa Dainin.TCF.015 ja jotta KEIMA on hyväksynyt ja katsoo, että rakennuksen tekniset tiedot ovat oikeat ja täysin vastaavat KEIMA:n sertifikaatin 74736-KRQ/EMC97-4957 mukaisesti.	22	Pastaba *	како изложено в Техничкој конструкцији Dainin.TCF.015 и потврђено KEIMA-ом према Сертификату 74736-KRQ/EMC97-4957.
05	Nota *	tal como se expone en el Archivo de Construcción Técnica Dainin.TCF.015 y juzgado positivamente por KEIMA según el Certificado 74736-KRQ/EMC97-4957.	14	Poznamka *	kako je izloženo u Datumi o tehničkoj konstrukciji Dainin.TCF.015 i pozitivno završeno KEIMA u skladu s ovjesticanim 74736-KRQ/EMC97-4957.	23	Pleziemes *	како је изложено у Суборне техничкој конструкцији Dainin.TCF.015, аблисној KEIMA позитивјам лемунам, ко аплика на ноекитс лемискаја документација Dainin.TCF.015, аблисној KEIMA позитивјам лемунам, ко аплика сертификат 74736-KRQ/EMC97-4957.
06	Nota *	delincato nel File Tecnico di Costruzione Dainin.TCF.015 e giudicato positivamente da KEIMA secondo il Certificato 74736-KRQ/EMC97-4957.	15	Napomena *	kako je izloženo u Datumi o tehničkoj konstrukciji Dainin.TCF.015 i pozitivno ocijenjeno od strane KEIMA prema Certifikatu 74736-KRQ/EMC97-4957.	24	Poznamka *	ако је изложено у Суборне техничкој конструкцији Dainin.TCF.015, аблисној KEIMA позитивјам лемунам, ко аплика сертификат 74736-KRQ/EMC97-4957.
07	Σημείωση *	όπως περιγράφεται στο Αρχείο Τεχνικής Κατασκευής Dainin.TCF.015 και κρίνεται θετικά από το KEIMA σύμφωνα με το Πρωτόκολλο 74736-KRQ/EMC97-4957.	16	Megjegyzés *	ahogy leírásban a Dainin.TCF.015 műszaki konstrukciós dokumentáció alapján, az a KEIMA igazolta a megfélelést az 74736-KRQ/EMC97-4957 tanúsítvány szerint.	25	Not *	Dainin.TCF.015 Technik Yan Dosyarsında beirdiligi ghu ve 74736-KRQ/EMC97-4957 sertifikasında göre KEIMA tarafından olumlu olarak değerlendirilmiştir.
08	Nota *	tal como estabelecido no Ficheiro Técnico de Construção Dainin.TCF.015 e com o parecer positivo de KEIMA de acordo com o Certificado 74736-KRQ/EMC97-4957.	17	Uwaga *	zgodnie z archiwalną dokumentacją konstrukcyjną Dainin.TCF.015 pozytywną opinią KEIMA i Świadectwem 74736-KRQ/EMC97-4957.			
09	Примечание *	как указано в доке технического согласования Dainin.TCF.015 и в соответствии с положительным решением KEIMA согласно Сертификату 74736-KRQ/EMC97-4957.	18	Nota *	conform celor stabilite în Dosarul tehnic de construcție Dainin.TCF.015 și apreciate pozitiv de KEIMA în conformitate cu Certificatul 74736-KRQ/EMC97-4957.			



Ch. Murata

Noboru Murata
Manager Quality Control Department
Shiga, 1st of Nov. 2006

DAIKIN INDUSTRIES, LTD.
Umeda Center Bldg., 4-12, Nakazaki-Nishi 2-chome,
Kita-ku, Osaka, 530-8323 Japan



Safety Precautions

- Read these Safety Precautions carefully to ensure correct installation.
- This manual classifies the precautions into WARNING and CAUTION.
- Be sure to follow all the precautions below: they are all important for ensuring safety.





 **WARNING**.....Failure to follow any of WARNING is likely to result in such grave consequences as death or serious injury.



 **CAUTION**.....Failure to follow any of CAUTION may result in grave consequences in some cases.

- The following safety symbols are used throughout this manual:

 Be sure to observe this instruction.	 Be sure to establish an earth connection.	 Never attempt.
--	---	--

- After completing installation, test the unit to check for installation errors. Give the user adequate instructions concerning the use and cleaning of the unit according to the Operation Manual.

 WARNING	
• Installation should be left to the dealer or another professional. Improper installation may cause water leakage, electrical shock, or fire.	
• Install the air conditioner according to the instructions given in this manual. Incomplete installation may cause water leakage, electrical shock, or fire.	
• Be sure to use the supplied or specified installation parts. Use of other parts may cause the unit to come to lose, water leakage, electrical shock, or fire.	
• Install the air conditioner on a solid base that can support the weight of the unit. An inadequate base or incomplete installation may cause injury in the event the unit falls off the base.	
• Electrical work should be carried out in accordance with the installation manual and the national electrical wiring rules or code of practice. Insufficient capacity or incomplete electrical work may cause electrical shock or fire.	
• Be sure to use a dedicated power circuit. Never use a power supply shared by another appliance.	
• For wiring, use a cable length enough to cover the entire distance with no connection. Do not use an extension cord. Do not put other loads on the power supply, use a dedicated power circuit. (Failure to do so may cause abnormal heat, electric shock or fire.)	
• Use the specified types of wires for electrical connections between the indoor and outdoor units. Firmly clamp the interconnecting wires so their terminals receive no external stresses. Incomplete connections or clamping may cause terminal overheating or fire.	
• After connecting interconnecting and supply wiring be sure to shape the cables so that they do not put undue force on the electrical covers or panels. Install covers over the wires. Incomplete cover installation may cause terminal overheating, electrical shock, or fire.	
• If any refrigerant has leaked out during the installation work, ventilate the room. (The refrigerant produces a toxic gas if exposed to flames.)	
• After all installation is complete, check to make sure that no refrigerant is leaking out. (The refrigerant produces a toxic gas if exposed to flames.)	
• When installing or relocating the system, be sure to keep the refrigerant circuit free from substances other than the specified refrigerant (R410A), such as air. (Any presence of air or other foreign substance in the refrigerant circuit causes an abnormal pressure rise or rupture, resulting in injury.)	
• During pump-down, stop the compressor before removing the refrigerant piping. If the compressor is still running and the stop valve is open during pump-down, air will be sucked in when the refrigerant piping is removed, causing abnormal pressure in the freezer cycle which will lead to breakage and even injury.	
• During installation, attach the refrigerant piping securely before running the compressor. If the compressor is not attached and the stop valve is open during pump-down, air will be sucked in when the compressor is run, causing abnormal pressure in the freezer cycle which will lead to breakage and even injury.	
• Be sure to establish an earth. Do not earth the unit to a utility pipe, arrester, or telephone earth. Incomplete earth may cause electrical shock, or fire. A high surge current from lightning or other sources may cause damage to the air conditioner.	
• Be sure to install an earth leakage breaker. Failure to install an earth leakage breaker may result in electric shocks, or fire.	

 CAUTION	
• Do not install the air conditioner in a place where there is danger of exposure to inflammable gas leakage. If the gas leaks and builds up around the unit, it may catch fire.	
• Establish drain piping according to the instructions of this manual. Inadequate piping may cause flooding.	
• Tighten the flare nut according to the specified method such as with a torque wrench. If the flare nut is tightened too hard, the flare nut may crack after a long time and cause refrigerant leakage.	
• Make sure to provide for adequate measures in order to prevent that the outdoor unit be used as a shelter by small animals. Small animals making contact with electrical parts can cause malfunctions, smoke or fire. Please instruct the customer to keep the area around the unit clean.	

Accessories

Accessories supplied with the outdoor unit:

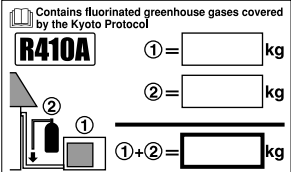
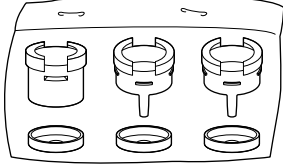
(A) Installation Manual	1	(B) Drain socket assy (HEAT PUMP ONLY)	
(C) Refrigerant charge label 	1		1

Precautions for Selecting the Location

- 1) Choose a place solid enough to bear the weight and vibration of the unit, where the operation noise will not be amplified.
- 2) Choose a location where the hot air discharged from the unit or the operation noise will not cause a nuisance to the neighbors of the user.
- 3) Avoid places near a bedroom and the like, so that the operation noise will cause no trouble.
- 4) There must be sufficient spaces for carrying the unit into and out of the site.
- 5) There must be sufficient space for air passage and no obstructions around the air inlet and the air outlet.
- 6) The site must be free from the possibility of flammable gas leakage in a nearby place.
- 7) Install units, power cords and inter-unit cables at least 3 meter away from television and radio sets. This is to prevent interference to images and sounds. (Noises may be heard even if they are more than 3 meter away depending on radio wave conditions.)
- 8) In coastal areas or other places with salty atmosphere of sulfate gas, corrosion may shorten the life of the air conditioner.
- 9) Since drain flows out of the outdoor unit, do not place under the unit anything which must be kept away from moisture.

NOTE

Cannot be installed hanging from ceiling or stacked.

CAUTION

When operating the air conditioner in a low outdoor ambient temperature, be sure to follow the instructions described below.

- 1) To prevent exposure to wind, install the outdoor unit with its suction side facing the wall.
- 2) Never install the outdoor unit at a site where the suction side may be exposed directly to wind.
- 3) To prevent exposure to wind, it is recommended to install a baffle plate on the air discharge side of the outdoor unit.
- 4) In heavy snowfall areas, select an installation site where the snow will not affect the unit.

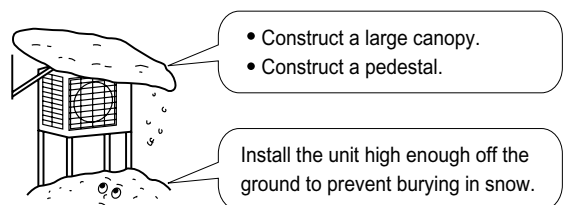

Outdoor Unit Installation Drawings

Max. allowable length	30m
** Min. allowable length	1.5m
Max. allowable height	20m
* Additional refrigerant required for refrigerant pipe exceeding 10m in length.	20g/m
Gas pipe	O.D. 15.9mm
Liquid pipe	O.D. 6.4mm

* Be sure to add the proper amount of additional refrigerant. Failure to do so may result in reduced performance.

** The suggested shortest pipe length is 1.5 m, in order to avoid noise from the outdoor unit and vibration. (Mechanical noise and vibration may occur depending on how the unit is installed and the environment in which it is used.)

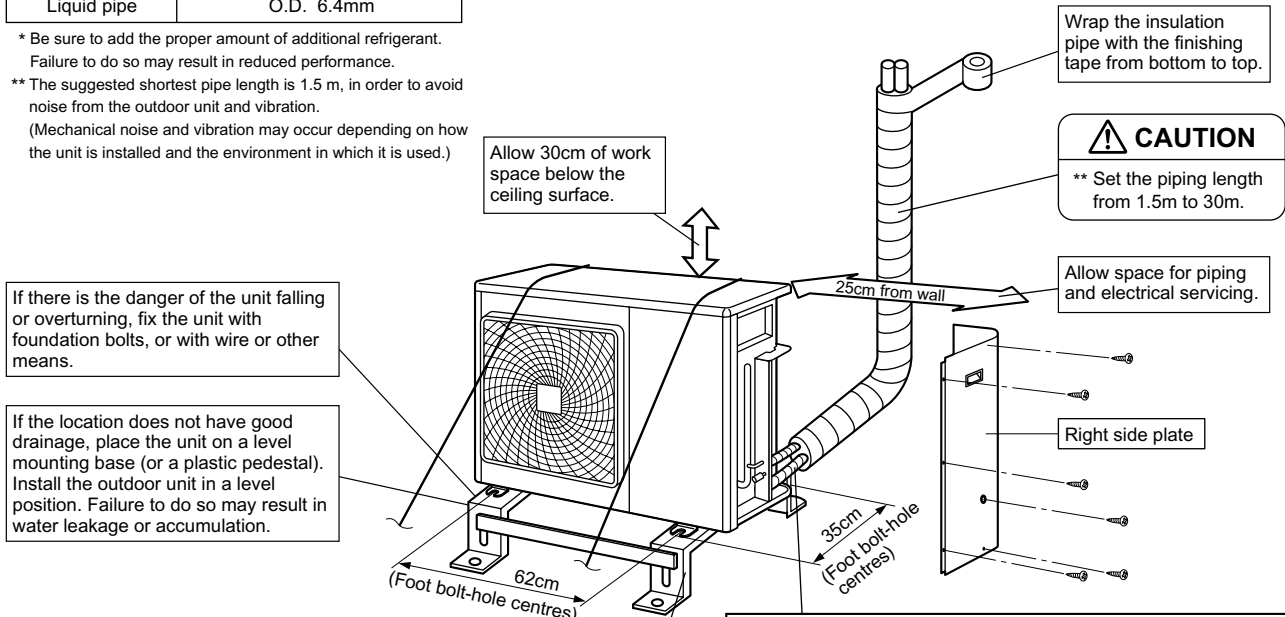

Also insulate the connection on the outdoor unit.

The diagram shows a cross-section of a pipe connection. It includes "Clamping material" around the pipe, an "Insulation tube" over the clamping material, "Tape" applied over the insulation tube, and a "Service lid" covering the end of the pipe.

Use tape or insulating material on all connections to prevent air from getting in between the copper piping and the insulation tube. Be sure to do this if the outdoor unit is installed above.

Installation Guidelines

- Where a wall or other obstacle is in the path of outdoor unit's intake or exhaust airflow, follow the installation guidelines below.
- For any of the below installation patterns, the wall height on the exhaust side should be 1200mm or less.

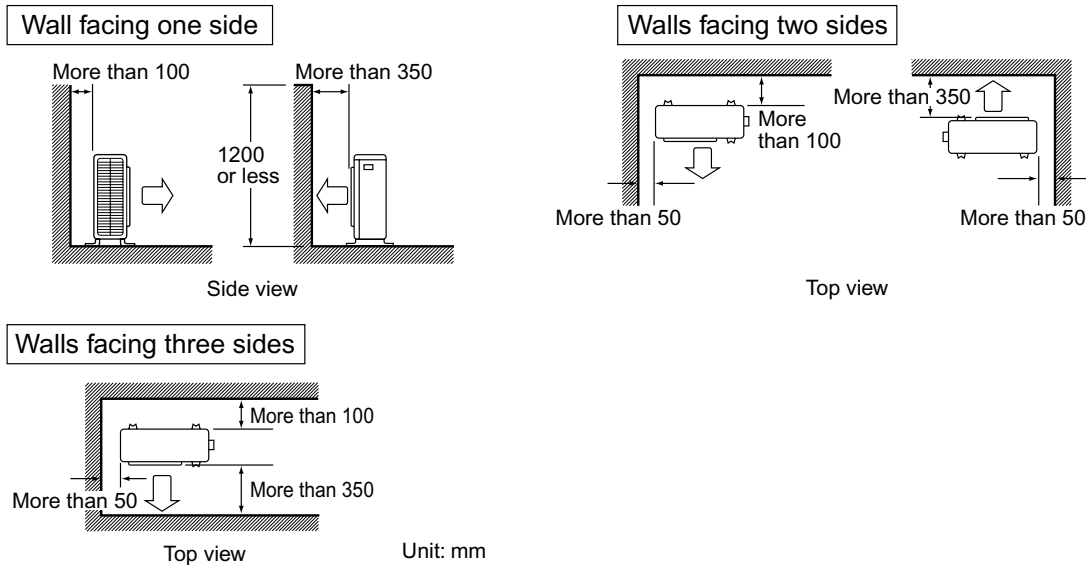

Precautions on Installation

- Check the strength and level of the installation ground so that the unit will not cause any operating vibration or noise after installed.
- In accordance with the foundation drawing, fix the unit securely by means of the foundation bolts. (Prepare four sets of M8 or M10 foundation bolts, nuts and washers each which are available on the market.)
- It is best to screw in the foundation bolts until their length are 20mm from the foundation surface.

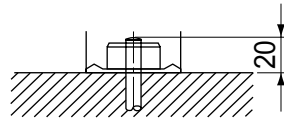

Outdoor Unit Installation

1. Installing Outdoor Unit

- 1) When installing the outdoor unit, refer to "Precautions for Selecting the Location" and the "Outdoor Unit Installation Drawings".
- 2) If drain work is necessary, follow the procedures below.

2. Drain Work

- Use drain plug for drainage.
- If the drain port is covered by a mounting base or floor surface, place additional foot bases of at least 100mm in height under the outdoor unit's feet.
- In cold areas, do not use a drain hose with the outdoor unit. (Otherwise, drain water may freeze, impairing heating performance.)

- 1) Insert drain receiver (C) onto drain socket (A) and drain cap (B) beyond 4 projections around drain socket and drain cap.
- 2) Insert drain socket and drain caps into their matching drain hole; Drain socket (A) into drain hole I and drain caps (B) into drain hole II and III. After insertion, turn them about 40° clockwise.

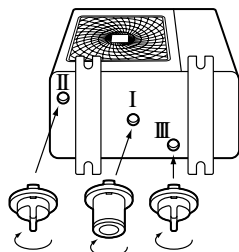

(Be sure not to insert them into wrong drain holes, or there causes water leakage.)

(View from bottom)

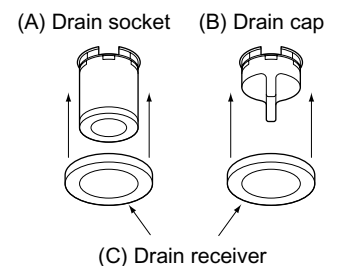

- 3) Connect vinyl hose on the market (internal diameter of 25 mm) to drain socket (A) (If the house is too long and hangs down, fix it carefully to prevent the kinks.)

NOTE

If the drain holes of the outdoor unit are covered with the mounting bracket or the floor, raise the unit to provide the space of more than 100mm under the leg of the outdoor unit.

Outdoor Unit Installation

3. Flaring the Pipe End

- 1) Cut the pipe end with a pipe cutter.
- 2) Remove burrs with the cut surface facing downward so that the chips do not enter the pipe.
- 3) Put the flare nut on the pipe.
- 4) Flare the pipe.
- 5) Check that the flaring is properly made.

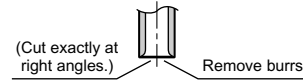

Set exactly at the position shown below.

Flaring		Conventional flare tool	
Flare tool for R410A		Clutch-type (Rigid-type)	Wing-nut type (Imperial-type)
A	0 ~ 0.5mm	1.0 ~ 1.5mm	1.5 ~ 2.0mm

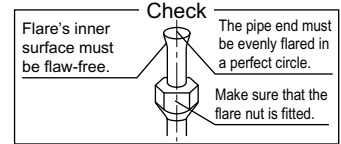

⚠ WARNING

- 1) Do not use mineral oil on flared part.
- 2) Prevent mineral oil from getting into the system as this would reduce the lifetime of the units.
- 3) Never use piping which has been used for previous installations. Only use parts which are delivered with the unit.
- 4) Do never install a drier to this R410A unit in order to guarantee its lifetime.
- 5) The drying material may dissolve and damage the system.
- 6) Incomplete flaring may cause refrigerant gas leakage.

4. Refrigerant Piping

- 1) Align the centres of both flares and tighten the flare nuts 3 or 4 turns by hand. Then tighten them fully with the torque wrenches.
 - Use torque wrenches when tightening the flare nuts to prevent damage to the flare nuts and escaping gas.
- 2) To prevent gas leakage, apply refrigeration oil on both inner and outer surfaces of the flare. (Use refrigeration oil for R410A.)

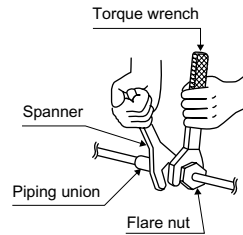
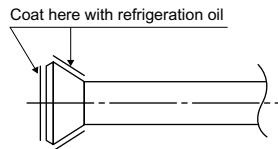

Flare nut tightening torque	
Gas side	Liquid side
5/8 inch	1/4 inch
61.8~75.4N • m (630~770kgf • cm)	14.2~17.2N • m (144~175kgf • cm)

Valve cap tightening torque	
Gas side	Liquid side
5/8 inch	1/4 inch
48.1~59.7N • m (490~610kgf • cm)	21.6~27.4N • m (220~280kgf • cm)

Service port cap tightening torque	10.8~14.7N • m (110~150kgf • cm)
------------------------------------	-------------------------------------

5. Purging Air and Checking Gas Leakage

- When piping work is completed, it is necessary to purge the air and check for gas leakage.

⚠ WARNING

- Do not mix any substance other than the specified refrigerant (R410A) into the refrigeration cycle.
- When refrigerant gas leaks occur, ventilate the room as soon and as much as possible.
- R410A, as well as other refrigerants, should always be recovered and never be released directly into the environment.
- Use a vacuum pump for R410A exclusively. Using the same vacuum pump for different refrigerants may damage the vacuum pump or the unit.

- If using additional refrigerant, perform air purging from the refrigerant pipes and indoor unit using a vacuum pump, then charge additional refrigerant.
- Use a hexagonal wrench (4mm) to operate the stop valve.
- All refrigerant pipe joints should be tightened with a torque wrench at the specified tightening torque.

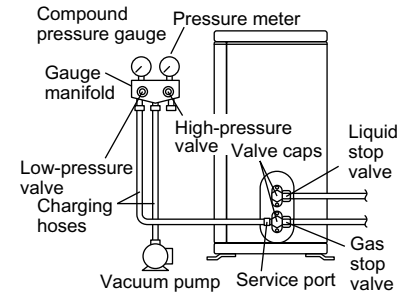

1) Connect projection side of charging hose (which comes from gauge manifold) to gas stop valve's service port.



2) Fully open gauge manifold's low-pressure valve (Lo) and completely close its high-pressure valve (Hi).
(High-pressure valve subsequently requires no operation.)



3) Do vacuum pumping and make sure that the compound pressure gauge reads -0.1MPa (-76cmHg)*1.



4) Close gauge manifold's low-pressure valve (Lo) and stop vacuum pump.
(Keep this state for a few minutes to make sure that the compound pressure gauge pointer does not swing back.)*2.



5) Remove covers from liquid stop valve and gas stop valve.



6) Turn the liquid stop valve's rod 90 degrees counterclockwise with a hexagonal wrench to open valve.
Close it after 5 seconds, and check for gas leakage.
Using soapy water, check for gas leakage from indoor unit's flare and outdoor unit's flare and valve rods.
After the check is complete, wipe all soapy water off.



7) Disconnect charging hose from gas stop valve's service port, then fully open liquid and gas stop valves.
(Do not attempt to turn valve rod beyond its stop.)



8) Tighten valve caps and service port caps for the liquid and gas stop valves with a torque wrench at the specified torques.

*1. Pipe length vs. vacuum pump run time

Pipe length	Up to 15 metres	More than 15 metres
Run time	Not less than 10 min.	Not less than 15 min.

*2. If the compound pressure gauge pointer swings back, refrigerant may have water content or a loose pipe joint may exist.
Check all pipe joints and retighten nuts as needed, then repeat steps 2) through 4).

Outdoor Unit Installation

6. Refilling the Refrigerant

Check the type of refrigerant to be used on the machine nameplate.

Precautions when adding R410A

Fill from the liquid pipe in liquid form.

It is a mixed refrigerant, so adding it in gas form may cause the refrigerant composition to change, preventing normal operation.

- 1) Before filling, check whether the cylinder has a siphon attached or not. (It should have something like "liquid filling siphon attached" displayed on it.)

Filling a cylinder with an attached siphon

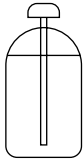

Stand the cylinder upright when filling.

(There is a siphon pipe inside, so the cylinder need not be upside-down to fill with liquid.)

Filling other cylinders



Turn the cylinder upside-down when filling.

- Be sure to use the R410A tools to ensure pressure and to prevent foreign objects entering.

Important information regarding the refrigerant used

This product contains fluorinated greenhouse gases covered by the Kyoto Protocol. Do not vent gases into the atmosphere.

Refrigerant type: **R410A**

GWP⁽¹⁾ value: **1975** ⁽¹⁾ GWP = global warming potential

Please fill in with indelible ink,

- ① the factory refrigerant charge of the product,
- ② the additional refrigerant amount charged in the field and
- ①+② the total refrigerant charge

on the refrigerant charge label supplied with the product.

The filled out label must be adhered in the proximity of the product charging port (e.g. onto the inside of the stop valve cover).

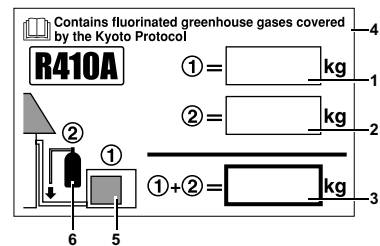

- 1 factory refrigerant charge of the product: see unit name plate
- 2 additional refrigerant amount charged in the field
- 3 total refrigerant charge
- 4 Contains fluorinated greenhouse gases covered by the Kyoto Protocol
- 5 outdoor unit
- 6 refrigerant cylinder and manifold for charging

7. Refrigerant Piping Work

7-1 Cautions on Pipe Handling

- 1) Protect the open end of the pipe against dust and moisture.
- 2) All pipe bends should be as gentle as possible. Use a pipe bender for bending. (Bending radius should be 30 to 40mm or larger.)

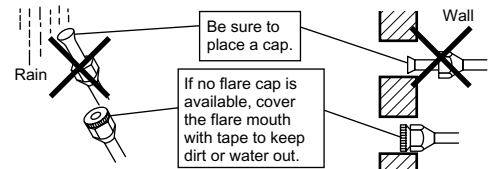

7-2 Selection of Copper and Heat Insulation Materials

When using commercial copper pipes and fittings, observe the following:

- 1) Insulation material: Polyethylene foam
Heat transfer rate: 0.041 to 0.052W/mK (0.035 to 0.045kcal/mh°C)
Refrigerant gas pipe's surface temperature reaches 110°C max.
Choose heat insulation materials that will withstand this temperature.
- 2) Be sure to insulate both the gas and liquid piping and to provide insulation dimensions as below.

Gas side	Liquid side	Gas pipe thermal insulation	Liquid pipe thermal insulation
O.D. 15.9mm	O.D. 6.4mm	I.D. 16-20mm	I.D. 8-10mm
Thickness 1.0mm	Thickness 0.8mm	Thickness 10mm Min.	

- Use separate thermal insulation pipes for gas and liquid refrigerant pipes.

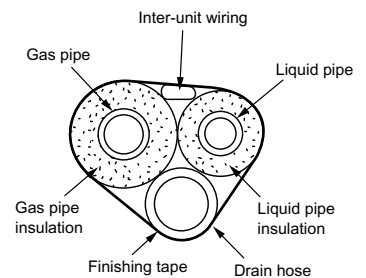

Pump Down Operation

In order to protect the environment, be sure to pump down when relocating or disposing of the unit.

- 1) Remove the valve cap from liquid stop valve and gas stop valve.
- 2) Carry out forced cooling operation.
- 3) After five to ten minutes, close the liquid stop valve with a hexagonal wrench.
- 4) After two to three minutes, close the gas stop valve and stop forced cooling operation.

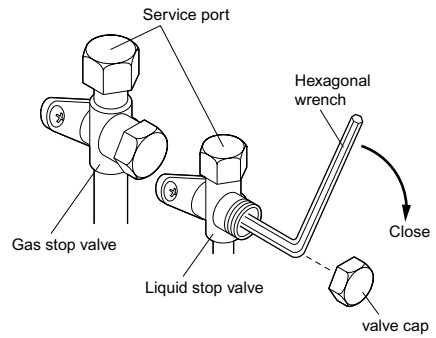

Forced cooling operation

- 1) Press the Forced Operation switch (SW1) to begin forced cooling. Press the Forced Operation switch (SW1) again to stop forced cooling.

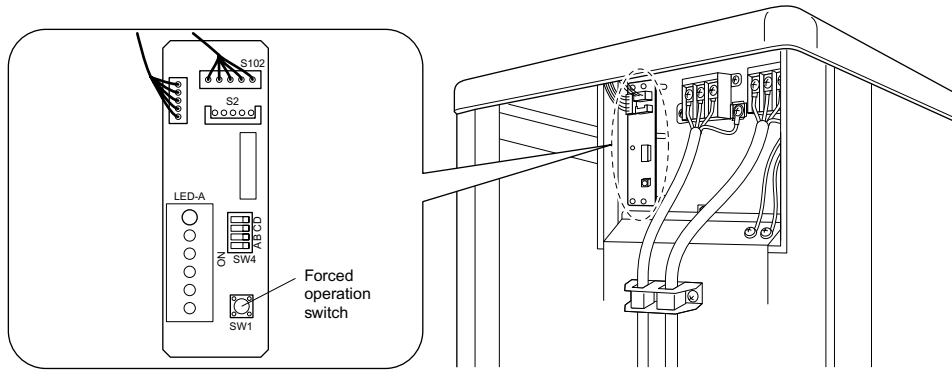

Wiring

⚠ WARNING

- 1) Do not use tapped wires, stranded wires, extensioncords, or starburst connections, as they may cause overheating, electrical shock, or fire.
- 2) Do not use locally purchased electrical parts inside the product. (Do not branch the power for the drain pump, etc., from the terminal block.) Doing so may cause electric shock or fire.
- 3) Be sure to install an earth leak detector. (One that can handle higher harmonics.)
(This unit uses an inverter, which means that it must be used an earth leak detector capable handling harmonics in order to prevent malfunctioning of the earth leak detector itself.)
- 4) Use an all-pole disconnection type breaker with at least 3mm between the contact point gaps.

- Do not turn ON the safety breaker until all work is completed.

- 1) Strip the insulation from the wire (20mm).
- 2) Connect the connection wires between the indoor and outdoor units **so that the terminal numbers match**. Tighten the terminal screws securely. We recommend a flathead screw-driver be used to tighten the screws.

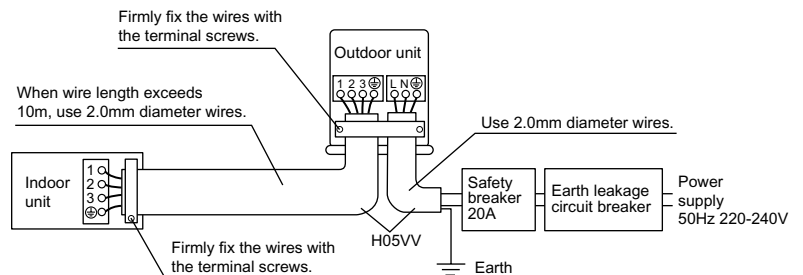

Wiring

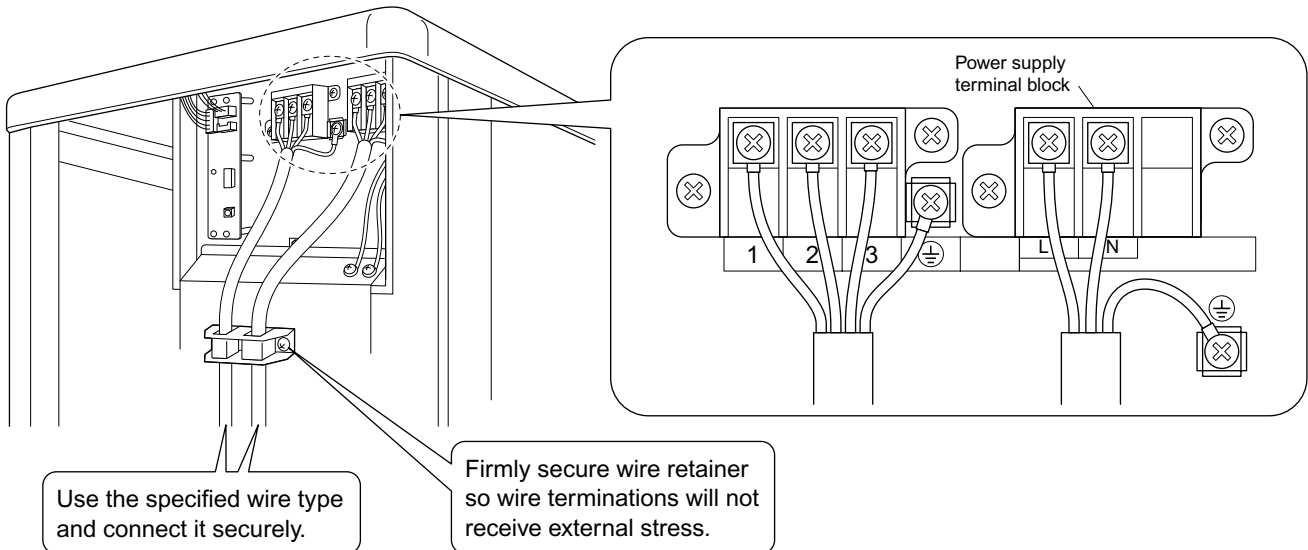

Observe the notes mentioned following when wiring to the power supply terminal board.

Precautions to be taken for power supply wiring.

Use a round crimp-style terminal for connection to the power supply terminal board. In case it cannot be used due to unavoidable reasons, be sure to observe the following instruction.

Place the round crimp-style terminals on the wires up to the covered part and secure in place.

- Ground terminal installation

Use the following method when installing the round crimp-style terminal.

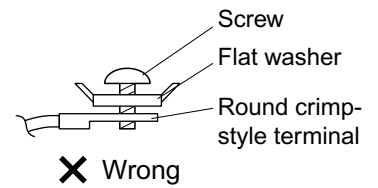
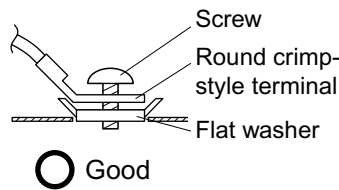
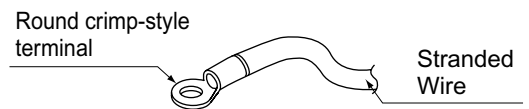

⚠ CAUTION

When connecting the connection wires to the terminal board using a single core wire, be sure to perform curling.

Problems with the work may cause heat and fires.

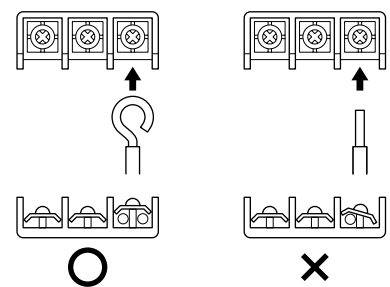

• Stripping wire at terminal block

3) Pull the wire and make sure that it does not disconnect. Then fix the wire in place with a wire stop.

Test Run and Final Check

1. Trial Operation and Testing

1-1 Measure the supply voltage and make sure that it falls in the specified range.

1-2 Trial operation should be carried out in either cooling or heating mode.

■ For Heat pump

- In cooling mode, select the lowest programmable temperature; in heating mode, select the highest programmable temperature.
 - 1) Trial operation may be disabled in either mode depending on the room temperature.
 - 2) After trial operation is complete, set the temperature to a normal level (26°C to 28°C in cooling mode, 20°C to 24°C in heating mode).
 - 3) For protection, the system disables restart operation for 3 minutes after it is turned off.

■ For Cooling only

- Select the lowest programmable temperature.
 - 1) Trial operation in cooling mode may be disabled depending on the room temperature.
 - 2) After trial operation is complete, set the temperature to a normal level (26°C to 28°C).
 - 3) For protection, the unit disables restart operation for 3 minutes after it is turned off.

1-3 Carry out the test operation in accordance with the Operation Manual to ensure that all functions and parts, such as louver movement, are working properly.

- The air conditioner requires a small amount of power in its standby mode. If the system is not to be used for some time after installation, shut off the circuit breaker to eliminate unnecessary power consumption.
- If the circuit breaker trips to shut off the power to the air conditioner, the system will restore the original operation mode when the circuit breaker is opened again.

2. Test Items

Test Items	Symptom	Check
Indoor and outdoor units are installed properly on solid bases.	Fall, vibration, noise	
No refrigerant gas leaks.	Incomplete cooling/heating function	
Refrigerant gas and liquid pipes and indoor drain hose extension are thermally insulated.	Water leakage	
Draining line is properly installed.	Water leakage	
System is properly earthed.	Electrical leakage	
The specified wires are used for interconnecting wire connections.	Inoperative or burn damage	
Indoor or outdoor unit's air intake or exhaust has clear path of air. Stop valves are opened.	Incomplete cooling/heating function	
Indoor unit properly receives remote control commands.	Inoperative	

DAIKIN INDUSTRIES, LTD.

Head office:
Umeda Center Bldg., 2-4-12, Nakazaki-Nishi,
Kita-ku, Osaka, 530-8323 Japan

Tokyo office:
JR Shinagawa East Bldg., 2-18-1, Konan,
Minato-ku, Tokyo, 108-0075 Japan
<http://www.daikin.com/global/>

DAIKIN EUROPE NV

Zandvoordestraat 300, B-8400 Oostende, Belgium



Two-dimensional bar code is a code for manufacturing.

3P188780-1C **M06B071C** (0704) **HT**