

DAIKIN



INSTALLATION MANUAL

Split System air conditioners

FDYP125B8V1
FDYP200B8V1
FDYP250B8V1

FDQ125B8V3B
FDQ200B8V3B
FDQ250B8V3B

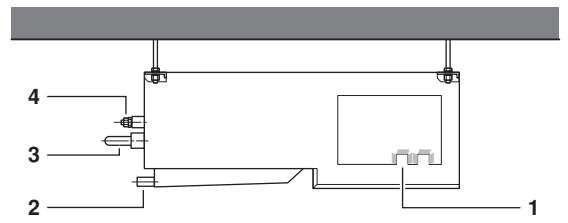
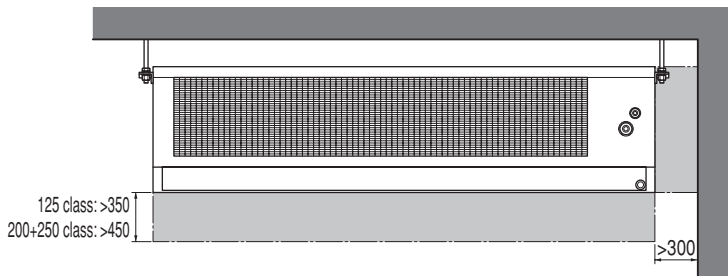

1

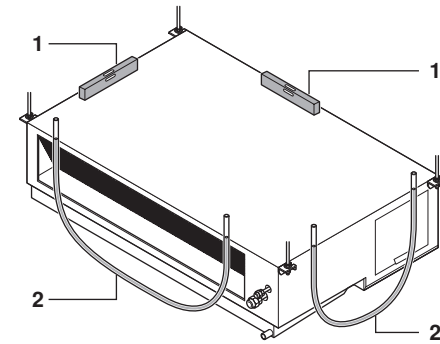
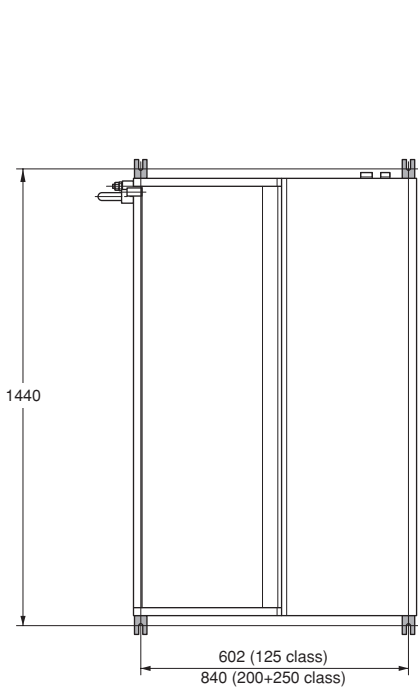

3

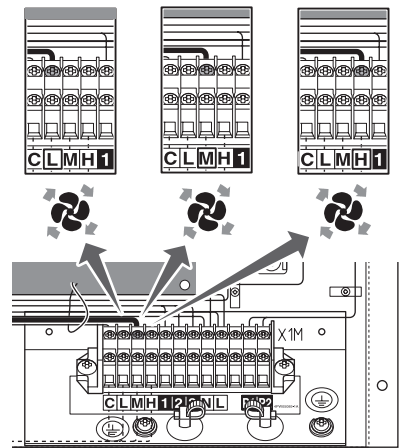
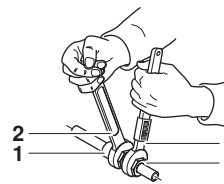

2

4

5

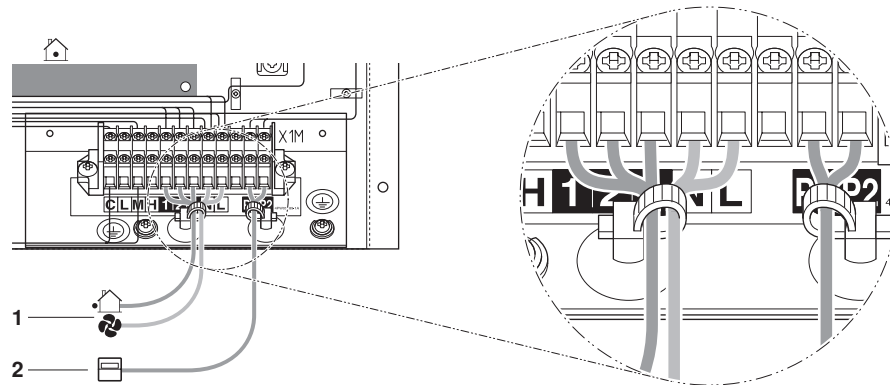

6

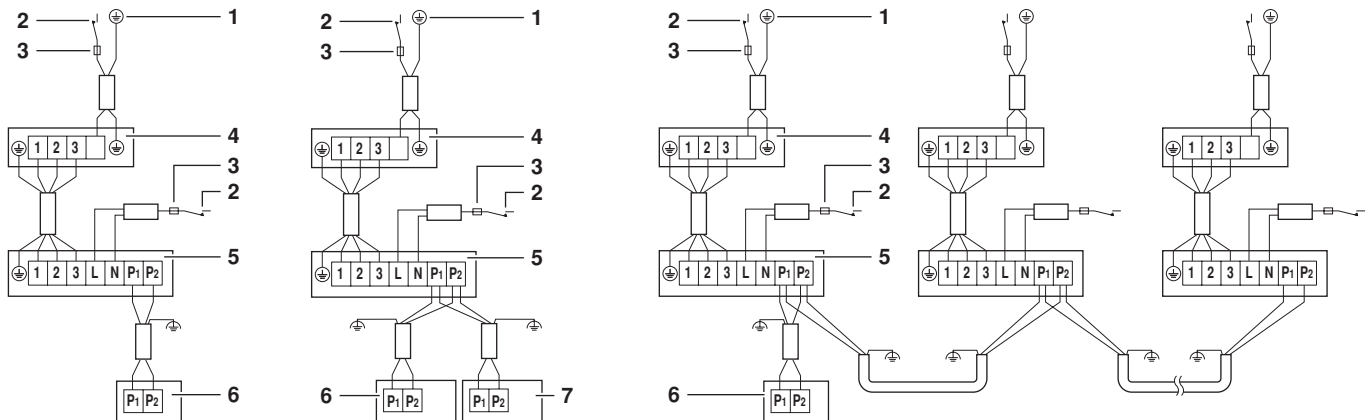

7

8

9

CE - DECLARATION-OF-COMFORMITY
CE - KONFORMITÄTSPERKLÄRUNG
CE - DECLARATION-DE-COFORMITE
CE - CONFORMITEITS/VERKLARING

Daikin Europe N.V.

CE - DECLARACION-DE-CONFORMIDAD
CE - DICHIARAZIONE-DI-COFORMITA
CE - ΔΗΛΩΣΗ ΣΥΜΜΟΡΦΩΣΗΣ

CE - DECLARACIÓN-DE-CONFORMIDAD
CE - ЗАЯВЛЕНИЕ-О-СОТВОРЕНИИ
CE - ОПЕЧЕЛЕНИЕ-СЕРТИФИКАЦИИ
CE - FÖRSÄKRAN-OM-ÖVERENSSTÄMMELSE

- 01 are in conformity with the following standard(s) or other normative document(s), provided that these are used in accordance with our instructions:
- 02 der/den folgenden Norm(en) oder einem anderen Normdokument oder Dokumenten entspricht/en entsprechen, unter der Voraussetzung, daß sie gemäß unseren Anweisungen eingesetzt werden:
- 03 são conformes à(s) norma(s) ou outro(s) documento(s) normativos, desde que estes sejam utilizados de acordo com as nossas instruções:
- 04 conform de volgen de norm(en) of één of meer andere bindende documenten z/n, op voorwaarde dat ze worden gebruikt overeenkomstig onze instructies:
- 05 están en conformidad con la(s) norma(s) u otro(s) documento(s) normativos, siempre que sean utilizados de acuerdo con nuestras instrucciones:
- 06 sono conformi alle seguenti(i) standard(i) o altro(i) documento(i) a carattere normativo, a patto che vengano usati in conformità alle nostre istruzioni:
- 07 είναι σύμφωνα με τα ακόλουθα(τα) πρότυπα(τα) ή άλλα έγγραφα(τα) κανονισμών, υπό την προϋπόθεση ότι χρησιμοποιούνται σύμφωνα με τις οδηγίες μας:
- 08 déclare sous sa seule responsabilité que les appareils d'air conditionné visés par la présente déclaration:
- 09 erklärt auf seine alleinige Verantwortung die Geräte der Klimageräte für die diese Erklärung bestmimmt ist:
- 10 déclare sous sa seule responsabilité que les appareils d'air conditionné visés par la présente déclaration:
- 11 verklaart hierbij op eigen exclusieve verantwoordelijkheid dat de airconditioning units waarop deze verklaring betrekking heeft:
- 12 declara bajo su única responsabilidad que los modelos de aire acondicionado a los cuales hace referencia la declaración:
- 13 δηλώνει sotto sua responsabilità che i condizionatori modello a cui è riferita questa dichiarazione:
- 14 δηλώνει με αποκλειστική της ευθύνη ότι τα μοντέλα των κλιματιστικών οροκλιών στα οποία αναφέρεται η παρούσα δήλωση:
- 15 déclare sob sua exclusiva responsabilidade que os modelos de ar condicionado a que esta declaração se refere:

FDYP125B8V1*, FDYP200B8V1*, FDYP250B8V1*,
FDQ125B8V3B*, FDQ200B8V3B*, FDQ250B8V3B*,
*, 1, 2, 3, ..., 9

- 01 Note * as set out in and judged positively by
- 02 Hinweis * wie in der aufgeführt und von positiv beurteilt gemäß Zertifikat
- 03 Remarque * le que défini dans et évalué positivement par conformément au Certificat
- 04 Bemerk * zoals vermeld in en positief beoordeeld door overeenkomstig certificaat
- 05 Nota * como se establece en y es valorado positivamente por de acuerdo con el Certificado
- 06 Nota * delineato nei e giudicato positivamente da secondo il Certificato
- 07 Znamenak * oznaka koju kvantna tvrtka, koja je ovlaštena za izdavanje ovog certifikata, ocijeni pozitivno prema ovom certifikatu
- 08 Nota * tal como estabelecido em e com o parecer positivo de de acordo com o Certificado
- 09 Примечание * как указано в и в соответствии с сопроводительным решением согласно данному сертификату
- 10 Bemerk * som antogs i og positivt vurderet af i henhold til Certificat
- 11 Information * enigi och godkänns av enligt Certificatet
- 12 Merk * som del förenklerneri og godkjennt av i henhold til dette anerkendes i henhold til våre instruksjoner:
- 13 Huom * jolla on esitetty asiakirjassa ja joka on tarkastettu myyjäisjärjestelmän mukaisesti.
- 14 Pozornia * jak bylo uvedeno v a pozitivně zjištěno v souladu s osvědčením
- 15 Napomena * kako je izloženo u pozitivno ocijenjeno od strane prema Certificatu
- 16 Megjegyzás * a(z) alapján, a(z) igazolta a megjelölt, a(z) tanúsítványt szerint.
- 17 Uwaga * zgodnie z dokumentacją pozytywną opinią Swiadectwem
- 18 Nota * asa cum este stabilit in si anexat pozitiv hysajstrijii/Sertifikatului mukasasti.
- 19 Opomba * kaj je dobljeno v in odobreno s strani v skladu s osvedčenim
- 20 Märkus * kako je izloženo u pozitivno ocijenjeno od strane prema Certificatu
- 21 Zabeleška * kartu je razloženo v i ocenjeno pozitivno od o skladu s Svidetstvom
- 22 Pastaba * kaip nustatyta ir kaip teigiamai išvertėta pagal Sertifikatą
- 23 Pezinaš * ką nurodė an atliksis pozityviam vertinimam susaiaia s sertifikatu
- 24 Poznamka * ako bilo uvedeno v a pozitivno zabele v skladu s osvedčenim
- 25 Not * <A> da bejrtligi gbi ve <C> Sertifikasna gřeje tarindan oiumu olarak degendendridigi gbi.

CE - DEKLARACIJA-DE-CONFORMITATE
CE - IZJAVA-O-USKLABENOSTI
CE - MEGFELELŐSÉG-NYILATKOZAT
CE - DEKLARACIJA-ZGODNOSCI
CE - DECLARAȚIE-DE-CONFORMITATE

CE - IZJAVA-O-USKLABENOSTI
CE - MEGFELELŐSÉG-NYILATKOZAT
CE - DEKLARACIJA-ZGODNOSCI
CE - DECLARAȚIE-DE-CONFORMITATE

CE - IZJAVA-O-USKLABENOSTI
CE - MEGFELELŐSÉG-NYILATKOZAT
CE - DEKLARACIJA-ZGODNOSCI
CE - DECLARAȚIE-DE-CONFORMITATE

CE - ATTIKITES-DEKLARACIJA
CE - ATBLISTBAS-DEKLARACIJA
CE - VYHLAŠENIE-ZHODY
CE - UYUMLUKLUK-BİLDİRİSİ

- 09 (B) заявляет, исключительно под свою ответственность, что модели кондиционеров воздуха, к которым относится настоящая заявка:
- 10 (B) erklærer under enansvar, at klimaanlægsmødelerne, som denne deklaration vedrører:
- 11 (S) deklarerar i egen skap av huvudansvar, att luftkonditioneringsmodellerna som berörs av denna deklaration innebär att:
- 12 (N) erklærer et fuldtændigt ansvar for at de luftkonditioneringsmodeller som berøres af denne deklaration indebærer at:
- 13 (NB) ilmoittaa yksinomaan omalla vastuullaan, että tämän ilmoituksen tarkoituksena ilmoitettuihin malliin:
- 14 (S2) prohlásuje ve své plné odpovědnosti, že modely klimatizácie, k nimž sa toto prohlásenie vzťahuje:
- 15 (FB) izjavlja pod sklopivo vlastitno odgovornostu da su modeli klima uređaja na koje se ova izjava odnosi:
- 16 (T) jelje felelősség tudatában kijelent, melyekre e nyilatkozat vonatkozik:

- 17 (T) deklaruje na własną odpowiedzialność, że modele klimatyzatorów, których dotyczy niniejsza deklaracja:
- 18 (B) deklariert die apparate de aer conditionné la care se referă această declarație:
- 19 (S2) z viso odgovornostjo izjavja, da so modeli klimatskih naprav, na katere se izjava nanaša:
- 20 (BT) kinnitab oma täieliku vastutuse, et kaasaõva deklaratsioonidele kuuluvad kliimaseadmete mudelid:
- 21 (BS) deklariira na oman ottevõetust, et moodelena klimatizatsiooni seadmed, mille kohta see otsus on antud, kuuluvad kliimaseadmete mudelid:
- 22 (T) visšie savo atsakomybę skelbia, kad oro kondicionavimo prietaisų modeliai, kuriems yra taikoma ši deklaracija:
- 23 (V) a plinu abilitubii apliceana, ca toate uzskaitito modelu gasei konditioneilați, uz kuriem aliteasa și deklaracija:
- 24 (S2) vyhlásuje na vlastnú zodpovednosť, že tieto klimatizačné modely, na ktoré sa vzťahuje toto vyhlásenie:
- 25 (T) lanamen kendri sorumlulukunda otnak uzare bi bildirimi oluğu, klima modellerinin asgudaki gbi olubunu beyan eder:

- 08 estão em conformidade com a(s) seguinte(s) norma(s) ou outro(s) documento(s) normativo(s), desde que estes sejam utilizados de acordo com as nossas instruções:
- 09 соответствуют следующим стандартам или другим нормативным документам, при условии их использования согласно нашим инструкциям:
- 10 ovenholder følgende standard(er) eller andre andre retningsgivende dokument(er), brudat af disse anerkendes i henhold til vores instruksjoner:
- 11 respektive utrustning är utförd i överensstämmelse med och följer följande standard(er) eller andra normgivande dokument, under förutsättning att användning sker i överensstämmelse med våra instruktjoner:
- 12 respektive utstyr er i overensstemmelse med følgende standard(er) eller andre normgivende dokument(er), under forutsætning av at disse brukes i henhold til våre instruksjer:
- 13 rastaraat seuraavien standardien ja muiden ohjeellisten dokumenttien vaatimuksissa edellyttäen, että niitä käytetään ohjeidemme mukaisesti:
- 14 za predpokrdu, že sou vzhátny v souladu s našimi pokyny, odpovídají následujícím normám nebo normativním dokumentům:
- 15 u skladu sa slijedećim standardom(im) ili drugim normativnim dokumentom(im), uz uvjet da se oni koriste u skladu s našim uputama:

- 16 megfelelnek az alábbi szabvány(ok)nak vagy egyéb irányadó dokumentum(ok)nak, ha azokat e bírás szertint használják:
- 17 spełniają wymogi następujących norm i innych dokumentów normalizacyjnych, pod warunkiem że używane są zgodnie z naszymi instrukcjami:
- 18 sunt în conformitate cu următorii (următoare) standarde (sau altele) documentale (normative), cu condiția ca acestea să fie utilizate în conformitate cu instrucțiunile noastre:
- 19 skladni naslednjih standardi in drugih normativi, pod pogojem, da se uporabljajo v skladu z našimi navodili:
- 20 an vastavuse järgmis (ie standard) (ie) v leste normaliseeritud dokumentidele, kui need kasutatakse vastavalt meie juhendile:
- 21 съответстват на следните стандарти или други нормативни документи, при условие, че се използват съгласно нашите инструкции:
- 22 atitinka žemiau nurodytus standartus ir (arba) kitus norminius dokumentus su sąlyga, kad yra naudojami pagal mūsų nurodymus:
- 23 iad, ja leibti atbilstošaj razloženíu nordenim, abis se kojichim standardim in citem normativnim dokumentim:
- 24 sú v zhode s nasledovnými normou (ami) alebo inými (mi) normatívnymi (i) dokumentom (ami), za predpokladu, že sa používajú v súlade s našimi návodmi:
- 25 inünin, lalmatlarınza göre kulanimasla asgudaki standartlar ve norm belirlen belgelerle uyumludur:

EN60335-2-40,

- 10 under regjeringsele at bestemmelseerne i:
- 11 enligt villkoren i:
- 12 gilt i henhold til bestemmelserne i:
- 13 noudatetaan määräyksiä:
- 14 za doozren ustanoveni priedpis:
- 15 prema odredbama:
- 16 követeli a(z):
- 17 zgodnie z postanowieniami Dyrektywy:
- 18 in urma prevederilor:
- 19 o upoštevanju doložb:
- 20 vastavalt määrdele:
- 21 smegadavku kravara ve:
- 22 laikantis nustatytų patalikių:
- 23 enerogiti prasibas, kas noredkias:
- 24 održavajuci uslanovenia:
- 25 bunun kosullarına uygun olarak:

- 01 Note * as set out in and judged positively by
- 02 Hinweis * wie in der aufgeführt und von positiv beurteilt gemäß Zertifikat
- 03 Remarque * le que défini dans et évalué positivement par conformément au Certificat
- 04 Bemerk * zoals vermeld in en positief beoordeeld door overeenkomstig certificaat
- 05 Nota * como se establece en y es valorado positivamente por de acuerdo con el Certificado
- 06 Nota * delineato nei e giudicato positivamente da secondo il Certificato
- 07 Znamenak * oznaka koju kvantna tvrtka, koja je ovlaštena za izdavanje ovog certifikata, ocijeni pozitivno prema ovom certifikatu
- 08 Nota * tal como estabelecido em e com o parecer positivo de de acordo com o Certificado
- 09 Примечание * как указано в и в соответствии с сопроводительным решением согласно данному сертификату
- 10 Bemerk * som antogs i og positivt vurderet af i henhold til Certificat

- 01 Directives, som amended:
- 02 Direktiven, gemäß Änderung:
- 03 Directives, telles que modifiées:
- 04 Richtlijnen, zoals gewijzigd:
- 05 Directivas, según lo emmendado:
- 06 Direktive, come da modifia:
- 07 Одржавни, отиук, џуов, протомонџет:
- 08 Direktivas, conforme alteraçao em:
- 09 Директиве со всеми поправками:
- 10 Direktiver, med senere ændringer:
- 11 Direktiv, med forøgete ændringer:
- 12 Direktive, с текщими изменениями:
- 13 Direktiveja, serlasnis kun te ovat muudetuna:
- 14 plārtiem zņem.
- 15 Snemica, kako je izmijeneno.
- 16 irányelvek és módosítások rendelkezései.
- 17 változásokkal módosított irányelvek.
- 18 Direktivelor, cu amendamentele respective:

- 19 Direktive z vsemi spremembami:
- 20 Direktivdi koos muudatustega:
- 21 Директиви, с текщими изменениями:
- 22 Direktives su papiljumioms:
- 23 Direktives v izmenjenih oblikih.
- 24 Snemica, v platnom znenu.
- 25 Degistirilmiş haldeki Yönetmelikler.

- 21 Zabeleška * kartu je razloženo v i ocenjeno pozitivno od o skladu s Svidetstvom
- 22 Pastaba * kaip nustatyta ir kaip teigiamai išvertėta pagal Sertifikatą
- 23 Pezinaš * ką nurodė an atliksis pozityviam vertinimam susaiaia s sertifikatu
- 24 Poznamka * ako bilo uvedeno v a pozitivno zabele v skladu s osvedčenim
- 25 Not * <A> da bejrtligi gbi ve <C> Sertifikasna gřeje tarindan oiumu olarak degendendridigi gbi.

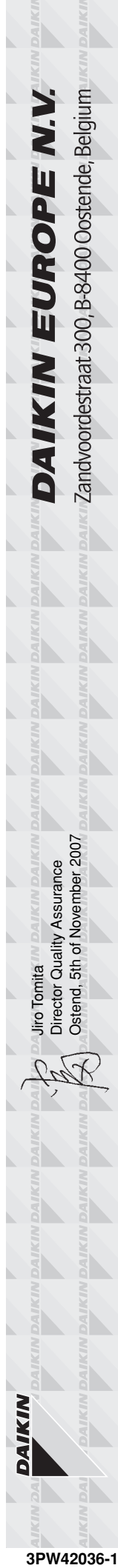

CONTENTS

	Page
Before installation.....	1
Installation site	1
Check list.....	2
Preparations before installation.....	2
Indoor unit installation	3
Refrigerant piping work	3
Vacuum drying of installation	3
Drain piping work	3
Drain check	4
Field wiring.....	4
Field setting.....	5
Test operation.....	5
Internal wiring - parts table.....	6

! READ THESE INSTRUCTIONS CAREFULLY BEFORE INSTALLATION.

KEEP THIS MANUAL IN A HANDY PLACE FOR FUTURE REFERENCE.

IMPROPER INSTALLATION OR ATTACHMENT OF EQUIPMENT OR ACCESSORIES COULD RESULT IN ELECTRIC SHOCK, SHORT-CIRCUIT, LEAKS, FIRE OR OTHER DAMAGE TO THE EQUIPMENT. BE SURE ONLY TO USE ACCESSORIES MADE BY DAIKIN WHICH ARE SPECIFICALLY DESIGNED FOR USE WITH THE EQUIPMENT AND HAVE THEM INSTALLED BY A PROFESSIONAL.

IF UNSURE OF INSTALLATION PROCEDURES OR USE, ALWAYS CONTACT YOUR DAIKIN DEALER FOR ADVICE AND INFORMATION.

BEFORE INSTALLATION

- Decide upon a line of transport.
- Leave the unit inside its packaging while moving, until reaching the installation site. Where unpacking is unavoidable, use a sling of soft material or protective plates together with a rope when lifting, to avoid damage or scratches to the unit.
- Refer to the installation manual of the outdoor unit for items not described in this manual.
- Caution concerning refrigerant series R410A:
 - The connectable outdoor units must be designed exclusively for R410A.
 - If outdoor units for R22, R407C are connected, the system will not work properly.

Accessories

Check if the following accessories are included with your unit.



Installation manual, Operation manual

Note to the installer

- Be sure to instruct the customer how to properly operate the system and show him/her the attached operation manual.
- Explain to the customer what system is installed on the site. Be sure to fill out the appropriate installation specifications in the chapter "What to do before operation" in the operation manual.

INSTALLATION SITE

1. Select an installation site where the following conditions are fulfilled and that meets your customers approval.
 - Is the air conditioner installed at a well-ventilated place where there are no obstacles around?
 - Do not install or use the air conditioner in the following places.
 - Filled with much mineral oil such as cutting oil;
 - Where there is much salt such as a beach area;
 - Where sulfured gas exists such as hot spring resorts;
 - Where there are considerable voltage fluctuations such as a factory or plant;
 - Vehicles and vessels;
 - Where there is much spray of oil and vapour such as a kitchen;
 - Where there are machines generating electromagnetic waves;
 - Filled with acid and/or alkaline steam or vapour.
 - Pay attention to operating noise.
 - Select a place where the ceiling is strong enough to support the unit and to prevent vibration and noise generation.
 - If abnormal noises occur, contact your dealer.
 - Where sufficient clearance for maintenance and service can be ensured (Refer to figure 1: ■ = service space). The power supply intake (1), the drain connection (2), gas pipe (3) and liquid pipe (4) connection should always be accessible for maintenance and service.
 - Where piping between indoor and outdoor units is possible within the allowable limit. (Refer to the installation manual for the outdoor unit.)
 - Where there is no danger of fire due to leakage of flammable gas. If the gas leaks out and stays around the air conditioner, a fire may break out.
 - Ensure that water can not cause any damage to the location in case it drips out of the unit (e.g. in case of a blocked drain pipe).

- Use suspension bolts for installation. Check whether the ceiling is strong enough to support the weight of the unit or not. If there is a risk, reinforce the ceiling before installing the unit.
- Install this unit where the bottom panel is more than 2.5 m above the floor so that the user cannot easily touch the unit.



- Do not use the air conditioner for other purposes. In order to avoid any quality deterioration, do not use the unit for cooling precision instruments, food, plants animals or works of art.
- Do not place appliances which produce open fire in places exposed to the air flow from the unit or under the indoor unit. It may cause incomplete combustion or deformation of the unit due to the heat.

CHECK LIST

For the following items, take special care during construction and check after installation is finished.

Tick ✓ when checked	
<input type="checkbox"/>	Is the indoor unit fixed firmly? The unit may fall down, vibrate or make noise.
<input type="checkbox"/>	Is the gas leak test finished? It may result in insufficient cooling.
<input type="checkbox"/>	Is the unit fully insulated? Condensate water may drip.
<input type="checkbox"/>	Does drainage flow smoothly? Condensate water may drip.
<input type="checkbox"/>	Does the power supply voltage correspond to that shown on the name plate? The unit may malfunction or components may burn out.
<input type="checkbox"/>	Are wiring and piping correct? The unit may malfunction or components may burn out.
<input type="checkbox"/>	Is the unit safely grounded? Danger of electric leakage.
<input type="checkbox"/>	Is the wiring size in accordance with specifications? The unit may malfunction or components may burn out.
<input type="checkbox"/>	Is nothing blocking the air outlet or inlet of either the indoor or outdoor units? It may result in insufficient cooling.
<input type="checkbox"/>	Are refrigerant piping length and additional refrigerant charge noted down? The refrigerant charge in the system might not be clear. This to avoid confusion for future maintenance and serving of the installation.
<input type="checkbox"/>	Are the air filters fixed properly (when installing with rear duct)? Maintenance of the air filters can be impossible.

PREPARATIONS BEFORE INSTALLATION

- Suspension bolt position (Refer to [figure 2](#)).
- The fan speed for this indoor unit is preset to provide standard external static pressure.
 - If higher or lower external static pressure is required, reset the external static pressure by changing the initial setting on the terminal in the indoor switchbox. Refer to the section entitled "[Field setting](#)" on [page 5](#).

NOTE



When connecting the air conditioning unit to the ducting, a pressure drop will be created and the evaporator airflow will be reduced. The maximum external static pressure may not exceed the following values:

Max. ESP	
FDYP125	150 Pa
FDYP200+250	250 Pa
FDQ125	150 Pa
FDQ200+250	250 Pa

- Install the suspension bolts (Refer to "[Installation example](#)" on [page 2](#)). Use M10 size bolt for the suspension bolt. Use anchors for existing ceilings, and a sunken insert, sunken anchor or other field supplied parts for new ceilings to reinforce the ceiling to bear the weight of the unit.

Installation example

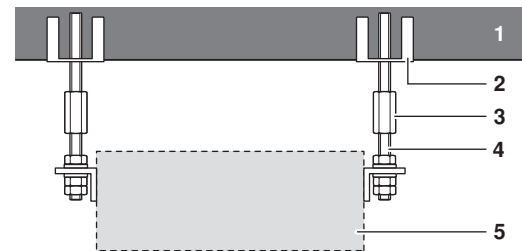

- Ceiling slab
- Anchor
- Long nut or turn-buckle
- Suspension bolt
- Indoor unit

Note: Mentioned parts are field supplied

INDOOR UNIT INSTALLATION

When installing optional accessories, refer to the instruction manual of each optional accessory. Depending on the field conditions, it may be easier to install optional accessories before the indoor unit is installed.

1. Install the indoor unit temporarily.
Attach the hanger bracket to the suspension bolt. Be sure to fix it securely by using a nut and washer from the upper and lower sides of the hanger bracket.

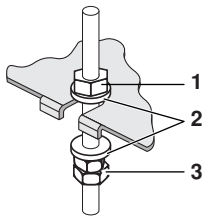

- 1 Field procurement.
- 2 Washer for hanger bracket
- 3 Tighten (double nut)

2. Do not install the unit tilted.
(If the unit is tilted against condensate flow, water can drip out of the drain pan).
Check if the unit is levelled at all four corners with a water level (1) or a water-filled vinyl tube (2) (Refer to figure 3).
3. Tighten the upper nut.
4. An air filter is installed to prevent dust accumulation on the heat exchanger. This will prolong the lifetime of the unit.
5. Connect the air inlet to the air inlet ducting and the air outlet to the air outlet ducting. Always provide a flexible connection between the ducting flanges of the air conditioner and the ducts to prevent vibrations and noise generation.



Ensure that a protective guard is installed in front of the air outlet to prevent that the fan blades can be touched. The protection must comply with relevant local and national regulations.

REFRIGERANT PIPING WORK



All field piping (liquid line and gas line between the condensing and the air conditioning unit) must be installed by a licensed refrigeration technician and must comply with relevant local and national regulations.

For refrigerant piping of outdoor unit, see the installation manual attached to the outdoor unit.

When installing field piping, take the following items into consideration:

- The outdoor unit is charged with refrigerant.
- Use a pipe cutter and flare suitable for the used refrigerant.
- The liquid line must be connected to the air conditioning unit via a flare connection. The gas line must be welded directly to the air conditioning unit piping. In case of a 125 unit, both the liquid line and the gas line must be connected to the air conditioning via a flare connection.
- In case of flare connections, flare the pipe end neatly to avoid refrigerants leaks.
- Be sure to use both a spanner and torque wrench together when connecting or disconnecting pipes to/from the unit (Refer to figure 4).

- 1 Piping union
- 2 Spanner
- 3 Flare nut
- 4 Torque wrench

- Refer to the table below for the dimensions of flare nut spaces.

Pipe gauge	Tightening torque	Flare dimension A (mm)		Flare shape
		R407C	R410A	
Ø6.4	14.2~17.2 N•m (144~176 kgf•cm)	8.3~8.7	8.7~9.1	
Ø9.5	32.7~39.9 N•m (333~407 kgf•cm)	12.0~12.4	12.8~13.2	
Ø12.7	49.5~60.3 N•m (504~616 kgf•cm)	15.4~15.8	16.2~16.6	
Ø15.9	61.8~75.4 N•m (630~770 kgf•cm)	18.6~19.0	19.3~19.7	
Ø19.1	97.2~118.6 N•m (990~1210 kgf•cm)	22.9~23.3	—	

- Because R407C/R410A refrigerant is used, apply ether or ester oil around the flare portions before connecting.
Coat here with ether oil or ester oil

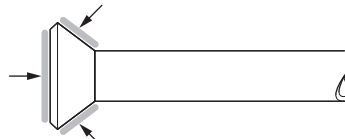

- Refer to the table above to determine the proper tightening torque. (Overtightening may damage the flare and cause leaks.)
- Check the pipe connector for gas leaks.
- Only wrap the gas line side of the insulation for fitting (union) with the sealing pad (attached).
- Use copper alloy seamless pipes (ISO 1337).

VACUUM DRYING OF INSTALLATION

Refer to the installation manual of the outdoor unit.

DRAIN PIPING WORK



- Arrange the drain hose to ensure smooth drainage. Incomplete drainage may cause the building to become wet.

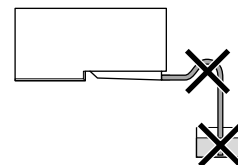

- The drain hose must slope downward to the outdoor side.
- Never put the end of the drain into water.

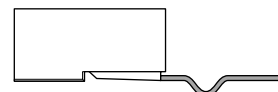

- A trap to prevent bad odours is allowed.
- If you extend the drain hose always insulate it up to the outdoor side with polyethylene foam insulation material (field supplied).

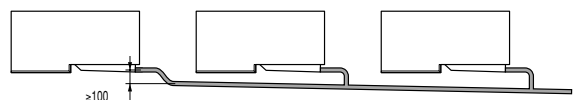

- To ensure a downward slope of minimum 1:100, install hanging bars every 1 to 1.5 m.
- If unifying multiple drain pipes, install pipes shown in the figure above.

DRAIN CHECK

Make sure that the drain hose is firmly connected. Put some water into the drain pan to check if the water flows smoothly.



If proper drainage is not carried out from the outdoor drain pipes during air conditioning operation, chances are that the pipe is clogged with dust and dirt. This may result in water leakage from the indoor unit. Under such circumstances, stop operation of the air conditioner and consult your dealer or air conditioner service station.

FIELD WIRING

General instructions



All wiring must be performed by an authorised electrician. All components procured on the site and all electric construction should comply with the applicable local and national codes.

High voltage

In order to avoid electric shock, make sure to disconnect the power supply 1 minute or more before servicing the electrical parts. Even after 1 minute, always measure the voltage at the terminals of main circuit capacitors or electrical parts and, before touching, make sure that those voltages are 50 V DC or less.

- Use copper wiring only.
- Follow the "Wiring diagram" attached to the switchbox cover to wire the outdoor unit, indoor units and remote controller. For details on hooking up the remote controller, refer to the "installation of the remote controller". For electric wiring work also refer to "Internal wiring - parts table" on page 6.
- A circuit breaker capable of shutting down the power supply to the entire system must be installed.
- Be sure to use a dedicated power circuit (a power supply not shared by another appliance).
- Refer to the installation manual attached to the outdoor unit for the size of the power supply electric wire connected to the outdoor unit, the capacity of the circuit breaker and switch, and wiring instructions.



- In order to avoid electric shock, make sure that an earth leakage breaker is installed.
- Be sure the air conditioner is electrically earthed. In order to avoid electric shock, make sure that the unit is grounded and that the earth wire is not connected to a gas or water pipe, lightning conductor or telephone earth wire.
- Never replace a fuse with that of a different ampere rating or other wires when a fuse blows. This may cause the unit to break down or cause a fire.
- When connecting or disconnecting a power supply cord, make sure that the current-carrying conductors become taut before the earthing conductor.

- Use a round crimp-style terminal for connection to the power supply terminal board. In case it cannot be used due to unavoidable reasons, be sure to observe the following instructions.
 - Do not connect wires of different gauge to the same power supply terminal. (Looseness in the connection may cause overheating.)

- When connecting wires of the same gauge, connect them in accordance with the figure below.



- Do not connect wires of different gauges to the same grounding terminal. Looseness in connection may deteriorate the protection.
- Use only specified wires and tightly connect wires to the terminals. Be careful that wires do not place external stress on the terminals. Keep wiring in neat order so that they do not obstruct other equipment such as popping open the switchbox cover. Make sure that the cover closes properly. Incomplete connections could result in overheating, and in the worse case, electric shock or fire.
- Use the correct screwdriver to tighten the terminal screws. Small screwdrivers can damage the screw head and prevent appropriate tightening. Over-tightening the terminal screws can damage the screws. The standard tightening torque is 0.9 N•m.

Electrical characteristics

For details, refer to "Electrical data".

Specifications for field wire

	Wire	Size (mm ²)	Length
Between indoor units	H05VV-U4G ^{(1),(2)}	1	—
Unit - remote controller	Sheathed wire (2 wire) ⁽³⁾	0.75–1.25	Max. 500 m ⁽⁴⁾
Indoor fan power supply	Must comply with relevant local and national regulations		

- (1) Shows only in case of protected pipes. Use H07RN-F in case of no protection.
- (2) Run transmission wiring between the indoor and outdoor units through a conduit to protect against external forces, and feed the conduit through the wall together with refrigerant piping.
- (3) Use double insulation wire for remote controller (sheath thickness: ≥1 mm) or run wires through a wall or conduit so that the user cannot come in contact with them.
- (4) This length shall be the total extended length in the system of the group control.

Precautions on electrical wiring work

- Before obtaining access to terminal devices, all supply circuits must be interrupted.
- Do not turn on the main switch until all the wiring is completed. Make sure that the main switch has a contact separation of at least 3 mm in all poles.

Methods of wiring units and connecting remote controller cords (See figure 6)

- Wiring the units (power supply wiring)
- Connect the interconnection wiring (from outdoor to indoor) to the 1-2-3 terminal (1) using a separate power supply of the indoor unit fan motor to the L-N terminal.
- Remote controller code. Connect the cords to the remote controller terminal (P1,P2) (No polarity) (2).

Precautions

- Do not clamp remote controller cords together with the other wiring. Doing so may cause malfunction.
- Do not place the controller where it is exposed to direct sunlight. The LCD display may get discolored, failing to display the data.
- Remote controller cords and wires connecting the units should be located at least 50 mm from other electric wires. Not following this guideline may result in malfunction.

Wiring example

Pair type (Refer to figure 7)

Remote controller controls 1 indoor unit (standard system).

Control by two remote controllers (Refer to figure 8)

Two remote controllers control 1 indoor unit.

Group control (Refer to figure 9)

Remote controller controls up to 16 indoor units.

(All indoor units operate according to the remote controller.)

(Refer to figure 7, figure 8 and figure 9).

- | | |
|---|--|
| 1 | Main power supply |
| 2 | Main switch |
| 3 | Fuse |
| 4 | Outdoor unit |
| 5 | Indoor unit |
| 6 | Remote controller |
| 7 | Remote controller (Optional accessories) |

NOTE



1. All transmission wiring except for the remote controller must match the terminal symbol.
2. Use shield wire in transmission wiring. Ground the shield of the shield wire to "⚡", at the grounding screw of the remote controller cord grounding the terminal inside the control box.
3. For group control remote controller, choose the remote controller that suits the indoor unit which has the most functions (as attached swing flap).
4. A single switch can be used to supply power to units on the same system. However, branch switches and branch circuits breakers must be selected carefully.
5. Do not ground the equipment on gas pipes, water pipes, lightning rods or crossground with telephones. Improper grounding could result in electric shock.

FIELD SETTING

Setting external static pressure

Depending on the external static pressure (ducts, filter, etc.) which is connected to the air conditioning unit the fan speed should be set by changing the wires in the switch box. (Refer to figure 5)

Factory set: fan speed is **M**.

High ESP: fan speed is **H**.

Low ESP: fan speed is **L**.

Setting air filter sign

- Remote controllers are equipped with liquid crystal display air filter signs to display the time to clean air filters.
- Change the SECOND CODE No. according to the table depending on the amount of dirt or dust in the room. (SECOND CODE No. is factory set to "01" for filter contamination-light.)

Setting	Spacing time of display air filter sign (long life type)	Mode No.	FIRST CODE No.	SECOND CODE No.
Air filter contamination-light	±2500 hrs	10 (20)	0	01
Air filter contamination-heavy	±1250 hrs			02

Setting the remote sensor

The customer has the ability to select the thermistor. Both unit and remote controller are equipped with a thermistor.

Setting

Setting	Mode No.	FIRST CODE No.	SECOND CODE No.
Enabled	20	2	01
Disabled	20	2	02

Change the second code n° according to the table to enable or disable the remote sensor.

TEST OPERATION

Refer to "Check list" on page 2.

After finishing the construction of refrigerant piping, drain piping, and electric wiring, conduct test operation accordingly to protect the unit.

1. Open the gas side stop valve.
2. Open the liquid side stop valve.
3. Electrify crank case heater for 6 hours.
4. Set to cooling operation with the remote controller and start operation by pushing ON/OFF button.
5. Press Inspection/Test Operation button 4 times and operate at Test Operation mode for 3 minutes.
6. Press Inspection/Test Operation button and operate normally.
7. Confirm function of unit according to the operation manual.

Precautions





In case something is wrong with the unit and it does not operate, refer to the malfunction diagnosis label attached to the unit.

INTERNAL WIRING - PARTS TABLE

Refer to the wiring diagram on the unit.

The abbreviations used are listed below.

NOTE	When using the central remote controller, see manual for connection to the unit.
	Ground the shield of the remote controller cord to the indoor unit.
	Be sure that power supply is switched off before opening switch box.
	The rated current of the fuse link F5U must be 16 A.

	: FIELD WIRING
	: TERMINAL
	: CONNECTOR
	: PROTECTIVE EARTH (SCREW)
BLK	: BLACK
BLU	: BLUE
RED	: RED
WHT	: WHITE
YLW	: YELLOW

A1P.....	Printed circuit board
A3P.....	Printed circuit board
C1R.....	Capacitor (fan)
F1T.....	Thermal fuse (M1F embedded)
F5U.....	Fuse
HAP, HBP.....	Light emitting diode (Service monitor - GREEN)
K1F.....	Magnetic contactor (M1F)
M1F.....	Motor (fan)
Q1DI.....	Earth leakage breaker
R1T.....	Thermistor (air)
R2T.....	Thermistor (coil)
RC.....	Signal receiver circuit
RyF1.....	Magnetic relay (fan)
SS1.....	Selector switch (emergency)
T1R.....	Transformer
TC.....	Signal transmission circuit
X1M.....	Terminal strip

Adaptor for wiring

RyC, RyF.....	Magnetic relay
---------------	----------------

Connector for optional parts

X25A.....	Connector (Group control adaptor)
X30A.....	Connector (interface adaptor for Sky Air series) (only for FDYP125~250)
X33A.....	Connector (Adaptor for wiring)
X40A.....	Connector (remote on/off, forced off)
X60A,X61A.....	Connector (interface adaptor for Sky Air series) (only for FDQ)

Wired remote controller

BS1.....	ON/OFF button
BS2.....	Timer mode start/stop button
BS3,BS8.....	Programming timer button
BS4.....	Temperature setting button up
BS6.....	Operation mode selector button
BS7.....	Timer on/off button
BS9.....	Temperature setting button down
BS12.....	INSPECTION/TEST operation button
BS14.....	Filter sign reset button
H1P.....	Light emitting diode (Service monitor-Red)
LCD.....	Liquid crystal display
SS1.....	Selector switch (MAIN/SUB)

